

V PUMP TECHNICAL MANUAL
MTV1
Description and Performance

The following instructions are usually valid for all V series internal gear pumps. For further details, consult the specific manuals for the various version. Additional information may be required for special pumps.

1 Introduction

1.1 Description

V series pumps are rotary positive displacement pumps. The rotation of two gears, one inside the other (items 1 and 2 in figure 1) create spaces which are subsequently closed when the gears mesh.

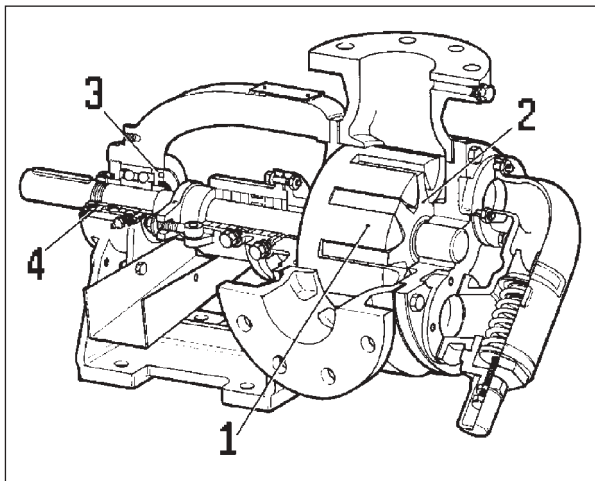

fig. 1

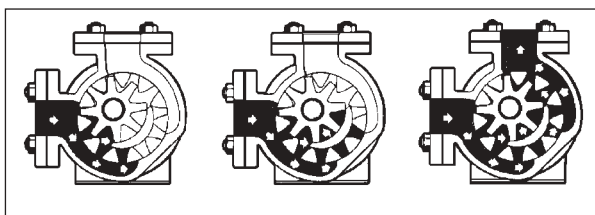

fig. 2

The rotor (1) causes the idler gear (2) to rotate. The combined effect of the rotation of these two gear is a constant displacement of volumes and therefore a flow at constant velocity, without pulsations or pressure peaks. This pumping principle makes for simple construction and is very versatile, permitting pumping of liquids of any viscosity. By adjusting the axial position of the rotor (which can be carried out without disassembling the pump), the same pump can handle very low viscosity liquids and liquids whose viscosity exceeds 50,000cst.

Figure 2 shows that the idler gear rotates inside the liquid and

is therefore easily lubricated, unlike other types of pumps which use other bearing systems, including external bearings.

The numbers of teeth on the two gears are not multiples one of the other; this means that wear is evenly distributed over the gears since each tooth on one gear touches each tooth on the other the same number of times.

The liquid which fills the spaces created between the gears in the suction area (figure 2) is carried between the gear teeth towards the discharge port. The two gears are eccentric and the space between them is taken up by a crescent on the front cover. At the discharge port, the gears mesh and the liquid is expelled. Since the pump is perfectly symmetrical it is evident that if the direction of rotation is changed, the flow will also change direction. The pump is therefore reversible.

The capacity of the pump is a function of the unit displacement and the rotation speed. The unit displacement is the volume displaced when the shaft is rotated through 360 degrees. In practice, the unit displacement is taken to be the capacity of the pump per revolution which zero pressure difference between the suction and discharge ports. The value obtained in this way takes into account the real physical configuration of the pump which may be different from the corresponding geometrical configuration.

The capacity can be changed by varying either the unit displacement or the rotation speed. The rotation speed can be changed by changing the ratio of the gear box drive or the engine speed, or by using a variable speed drive or inverter. The unit displacement can only be varied by changing the diameter or height of the gears. This means changing the pump model.

1.2 Advantages

The axial position of the rotor can be adjusted on all V series pumps without disassembly (except for V6, V12, V20, V25).

This is done by positioning the two threaded lock rings which lock the rear bearing (items 3 and 4 in figure 2). The position of the rotor with reference to the cover is adjusted by changing the axial position of the ball bearing. For further details refer to the instructions for the use of the various models.

The new generation of V pumps is modular; by this we mean that the components of each pump are interchangeable with others with different characteristics. In particular, casings and front and rear covers can be replaced by jacketed components, the by-pass relief valve can be mounted or removed, and the shaft seal can be changed with a choice of

different packed glands or mechanical seals by replacing the gland or seal box. Apart from the replacement of some components with others of a different type, a wide range of materials for various applications are available. For the choice of materials, consult in the table in paragraph 2.6.

1.3 Liquids handled

V internal gear rotary pumps can handle a wide range of liquids. The following list is only an example; it will be noted that these liquids have widely differing viscosities. Some have low or non-existent lubricity, and others are abrasive, some naturally and others because of filling.

Acetone, acids, alcohols, alkalis, asphalt, bitumen, blood, brine, bunker fuel, chemicals, chocolate, colours, cream, creosote, detergents, diesel fuel, ether, fat, freon, fuel oil, gelatine, glucose, glue, glycerine, glycols, heat transfer oil, isocyanate, kerosene, lacquer, lard, liquefied gases, lubricating oil, methanol, milk of lime, mineral oil, molasses, must, paint, petrol, petroleum, pharmaceuticals, pitch, plastifiers, polymer solutions, polyol, printers ink, resin, soap, sodium silicate, solvents, starch, syrup, tar, trichloroethylene, varnish, viscose, wax, wine.

The capacities and pressure limitations are different for each model. For further information, consult our sales office or the manuals for each version.

It should, however, be pointed out that the greater the rotation speed, the higher the wear at the points where there is the most friction, in particular between the idler pin and bush and between the gear teeth. If the liquid being pumped is non lubricating (very low viscosity), self-lubricating bushes must be mounted. If the liquid contains abrasive particles, the rotation speed and discharge pressure should be reduced and materials harder than the abrasive particle used.

At high temperatures, the clearances must be increased and heat resistant, materials used.

2 Nomenclature

2.1 Nomenclature

Figures 3 and 4 show cross sections of typical pumps where the components are identified with a number and corresponding description which will be used in all references.

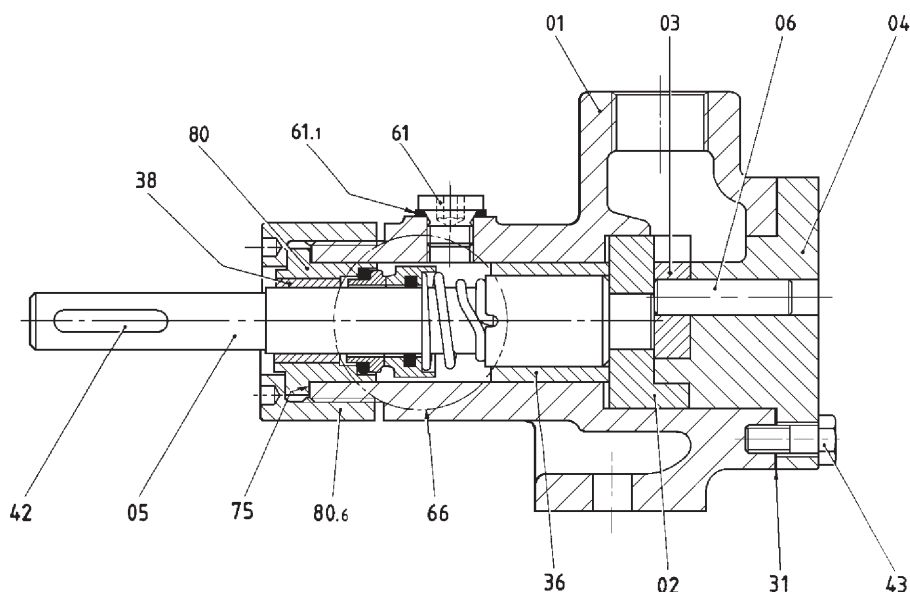

fig. 3

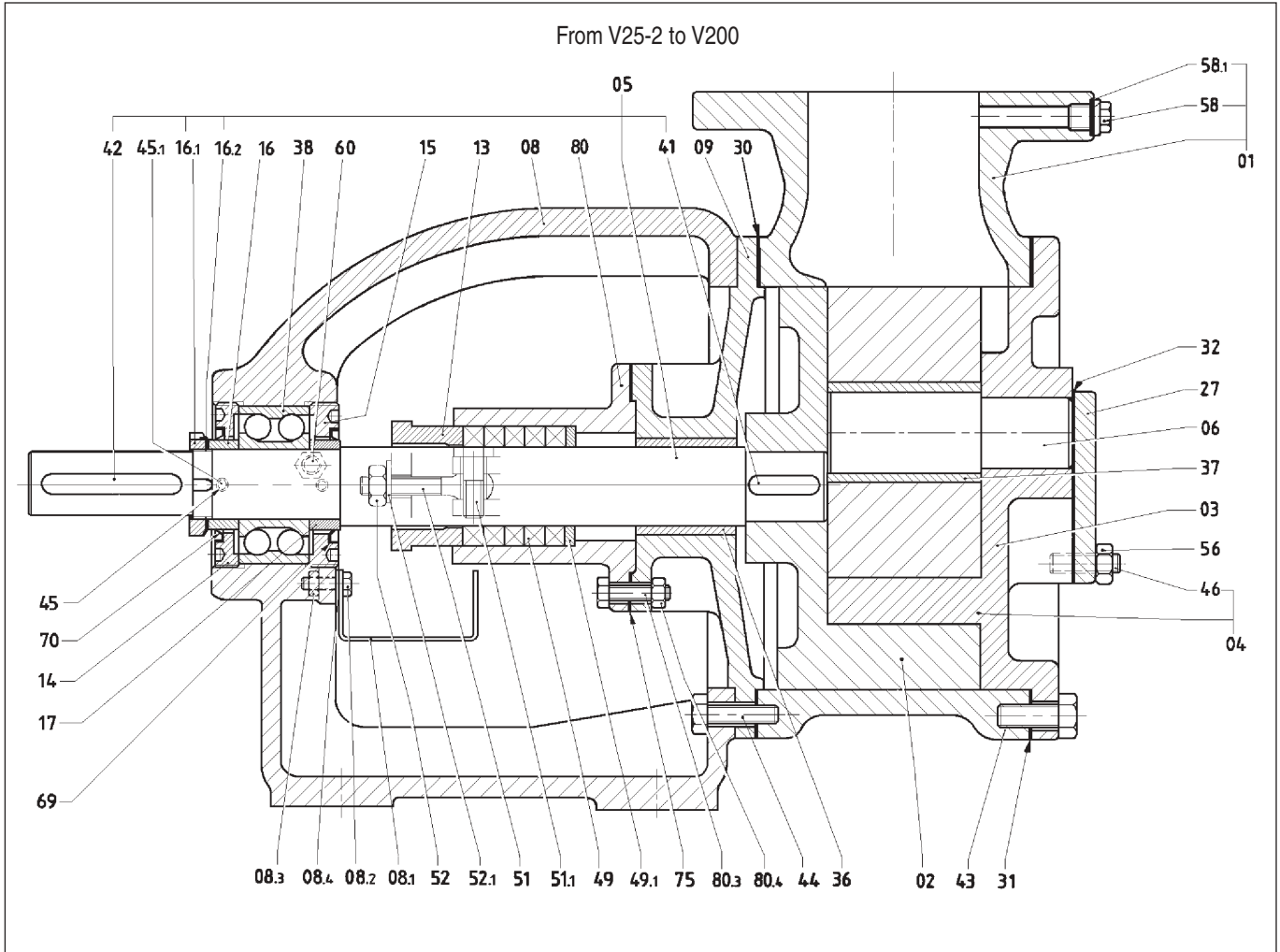

fig. 4

01 Casing	14 Outer bearing cover	41 Key	58 Plug
02 Rotor	15 Inner bearing cover	42 Key	58.1 Gasket
03 Idler	16 Outer lock ring	43 Screw	60 Grase nipple
04 Cover	16.1 Lock nut	44 Screw	61 Plug
05 Shaft assembly	16.2 Washer	45 Screw	61.1 Gasket
06 Idler pin	17 Inner lock ring	46 Stud	66 Mechanical seal ass.
08 Bearing housing	27 By-pass flange	49 Packing	69 Oil seal
08.1 Drip tray	30 Casing gasket	49.1 Ring	70 Oil seal
08.2 Screw	31 Cover gasket	51 Eyebolt	75 Seal box gasket
08.3 Nut	32 By-pass flange gasket	51.1 Screw	80 Seal box
08.4 Washer	36 Bearing bush	52 Nut	80.3 Screw
09 Rear cover	37 Idler bush	52.1 Washer	80.4 Nut
13 Gland	38 Bearing	56 Nut	80.6 Seal cover

2.2. Pump model designation

V series pumps have a model designation which describes the size, model and arrangement. The designation consists of a part describing the pump alone, separated by a bar that describing the drive. Pumps with belt or gear box drive have a third part between two bars giving the reduction ratio.

Example:

V80-2 **ST4W** **K** **+R2+O2+Y**
 1 2 3 4

- 1) Pump size
- 2) Type of shaft seal
- 3) Basic pump construction material
- 4) Options

Pump and drive assemblies

Example:

V30-2 ST5WG / **R3,7** / **Mc 304** + **BP**
 5 6 7 8

- 5) Pump model
- 6) Reduction ratio
- 7) Type of motor or engine
- 8) Arrangement (type of base plate or trailer)

Meaning of code letters

1) Pump model

2) Type of shaft seal

SP	packed gland
SP1	flushed packed gland
ST	graphite/AISI 431/nitrile mechanical seal (for V6, V12, V20, V25).
ST4	graphite/ceramic/PTFE mechanical seal (ST5 for V25-2, V30-2)
ST4W	carbide /PTFE mechanical seal
ST6	graphite/ceramic/Viton mechanical seal
ST6W	carbide/Viton mechanical seal
ST7-ST8	double mechanical seals (the seal materials are established case by case)
ST9	with external mechanical seal (N.B. : for this version, consult the manufacturers for materials selection).

3) Pump construction material

G	Cast iron
K	AISI 316 stainless steel
AT	Case hardened steel
BS	Anti gall treated cast iron
HTR	Cast iron construction for high temperatures with jacketed casing

4) Options (see paragraph 2.7)

F	with DIN flanges (only for V6, V12, V20, V25, V25-2, V30-2)
FA	with ANSI 125/150 flanges
O2	with quench liquid reservoir
R	with jacketed casing
R1	Heating (or cooling) jacket cast integral with the gland.
R2	Heating (or cooling) jacket on cover
R3	Heating (or cooling) jacket around the shaft seal (+R1) and around the casing (+R)
R4	Heating (or cooling) jacket on the cover (+R2) and around the shaft seal (+R1).
Y	with by-pass relief valve
YH	with by-pass with spring for high pressures
YR	with jacketed by-pass
YY	with double by-pass

6) Type of speed reduction

No code	direct drive
a number	coupled with V-belts; the number indicates the reduction ratio
R...	with gear box, followed by a number indicating the reduction ratio
V...	with variable speed drive, followed by two numbers indicating the minimum and maximum speeds

7) Type of motor or engine

Electric motor

Mc	TEFC (totally enclosed fan cooled) electric motor, IP55 protection, class F insulation
Md	Explosion proof electric motor
Mcc	DC electric motor (requires further description)

The digits which follow indicate the number of poles (last digit) and the power expressed in tenths of horsepower (the preceding digits).

Example: 552-3 = 5.5 HP, 2 pole, 380/660 V

Motors with IP 55 protection have this indicated after the voltage.

Internal combustion engines:

MAD	Acme diesel engine
MAP	Acme petrol engine
MAF	IVECO/Aifo diesel engine
MBS	Briggs & Stratton petrol engine
MZD	Deutz diesel engine
MHT	Hatz diesel engine
MLA	Intermotor petrol engine
MLD	Lombardini diesel engine
MRD	Ruggerini diesel engine
MSM	SAME diesel engine
MVM	VM diesel engine

8) Arrangement

- BP Base plate
- T Trolley or slow towing trailer
- CF Carrying frame

2.3 Suction and discharge ports

2.3.1 The two ports of V series pumps have the same size, because since the pumps are reversible, the suction port and delivery port cannot be determined a priori. The flow velocity in the pipework is very low, and since the Reynolds number is lower than 2000 the flow is laminar.

The V6 and V12 have 1/2" BSP tapped ports on the upper part of the casing. On request, DN 15 PN 16 flanges at 180° can be supplied. The V 25-2 and V 30-2 have 1 1/4" BSP tapped ports; on request, DN40 PN16 flanged ports can be supplied. All other models have flanged ports. Unless otherwise specified, the following flanges are supplied:

Cast iron pumps: UNI 2237-67 - PN16

Steel pumps: UNI 2240-67 - PN16

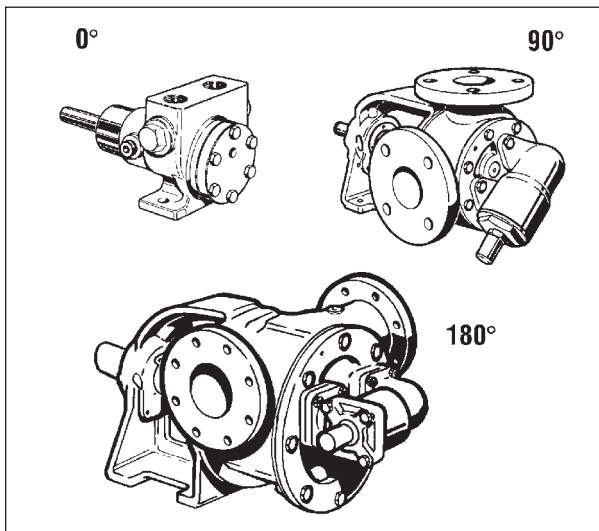

fig. 5

On request, the following can also be supplied:

Cast iron: ANSI 125 FF

Steel: ANSI 150 FF

RF according to UNI 2229-67 for UNI flanges

RF according to ANSI B16.5 for ANSI flanges

For flanges dimensions, refer to the specific drawings for each model.

Ports at 180 degrees are more convenient for installation in line, while those at 90 degrees are more easily adopted in plant where either the suction or discharge line is vertical. Casings with 90 degree ports can be further adapted to the pipework by rotating the casing through 90 degrees so that the suction port can be positioned to the right or left as shown in figure 6.

Unless otherwise specified in the order, pumps are supplied

with the suction port on the right hand side looking from the drive end.

NB: When rotating the casing, the cover must also be rotated. The liquid flow inside the pump takes the longer route between the ports (across the crescent).

If the by-pass is mounted on the cover, its regulation screw should point towards the suction port, while if it is mounted on top of the casing, the regulation screw should be on the discharge port side.

The ports can be at 0°, 90° or 180° as shown in figure 5 and in the following table:

V6 V12	V20 V25	V25-2 V30-2	V50-3	V60-2	V70-2	V80-2	V85-2
G K	G - K	G K	G K	G K	K	G K	G
0° 180°	180°	90°	90°	90° 180°	180°	90° 180°	90°

V90-2	V100-2	V120-2	V150-2	V151	V180	V200
K	G K	G	G K	K	G K	G K
90° (180°)	90° (180°)	90°	90°	90°	180°	180°

Key: G = Cast iron version

K = Stainless steel version

() = Non standard - ask for confirmation of feasibility and availability

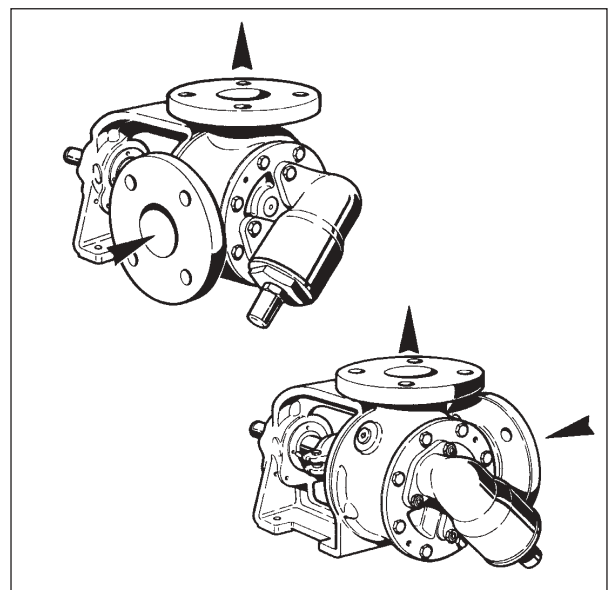

fig. 6

2.3.2 Maximum nozzle loads

The maximum loads which can be carried by cast iron and stainless steel flanges are shown below.

With reference (figure 6) to the plane of the flange and with origin at the centre of the flange, the following are defined:

- x axis parallel to the pump shaft lying on the flange plane
- y axis lying on the flange plane perpendicular to the x axis
- z axis orthogonal to the flange plane

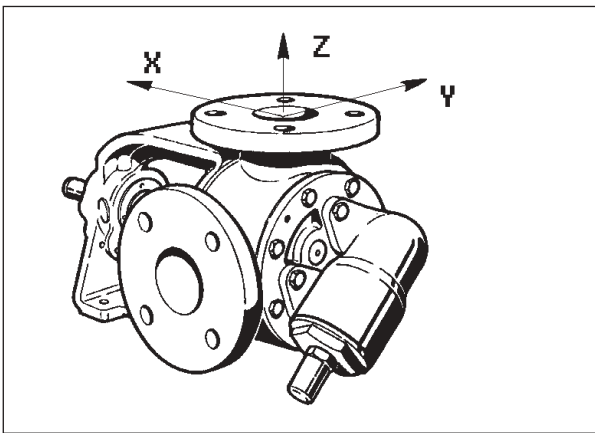

F_x, F_y, F_z Forces along the axes expressed in N (Newtons)
M_x, M_y, M_z Moment of flexure around the axes expressed in Nm (Newton metres)

The maximum loads permitted on the flanges are:

Pump type	D			F _{xyz}		M _{xyz}	
	mm	in		lb	N	lbf ft	Nm
V6, V12	15	0.6	G	27	120	44	60
			K	45	200	73	100
V20, V25, V25-2, V30-2	40	1.6	G	70	310	118	160
			K	119	530	199	270
V50-3, V60-2	50	2.0	G	88	390	147	200
			K	149	660	243	330
V70-2, V80-2	80	3.0	G	133	590	221	300
			K	225	1000	375	510
V85-2	100	4.0	G	178	790	294	400
V90-2	100	4.0	K	300	1330	500	680
V100-2	100	4.0	G	178	790	294	400
			K	300	1330	500	680
V120-2, V151	125	5.0	G	221	980	368	500
			K	376	1670	625	850
V150-2	150	6.0	G	266	1180	441	600
			K	450	2000	750	1020
V180, V200	200	8.0	G	354	1570	588	800
			K	601	2670	1000	1360

Pumps with tapped ports are not included.

2.4 Shaft seal

V series pumps can be supplied with packed gland or mechanical seal.

2.4.1 Packed gland

Packed glands are fitted as standard in the SP, SPG, SPAT, SPK, SPHT and SPHTR versions. The packing materials depend on the pump application. These versions are also available with flushing on the V25-2 up to the V200 (SP1). The flush can be used to provide a barrier or for lubrication if an appropriate liquid is fed in from outside, or for drainage if the liquid passing through the packing is removed. In this case, the flush can be connected to the pump suction port.

2.4.2 Mechanical seal

Mechanical seals are fitted as standard on the **ST4BS, ST4W, STWG, ST4K** and **ST4WK** versions.

T4 stands for a single mechanical seal with AISI 316 stainless steel driver and spring, graphite and ceramic seats, PTFE elastomers and rear static quench (**T5** for models V 25-2, V 30-2). **W** indicates that carbide (tungsten or silicon) seats are used.

The following mechanical seals can also be supplied:

- ST6** Mechanical seal as ST4, but with Viton elastomers
- ST7** Double tandem mechanical seal
- ST8** Double back to back seal
- ST9** External single seal (NB: The manufacturers must be consulted for this version.)

The material and lubrication system for these seals are decided on case by case depending on the customers' specific requirements.

Shaft seals

SP	Packed gland
SP1	Flushed or drained packed gland
ST4	ISO 3069 standard dimension mechanical seal . Graphite/ceramic with PTFE gaskets. A PTFE lip seal is mounted behind the main seal to contain a barrier liquid (Quench). On request, a quench liquid reservoir (+O2). For the V25-2 and V30-2, the denomination is ST5.
ST4W	ISO 3069 standard dimension mechanical seal . Tungsten or silicon carbide/ceramic with PTFE gaskets. A PTFE lip seal is mounted behind the main seal to contain a barrier liquid (Quench). On request, a quench liquid reservoir (+O2) can be supplied. For the V25-2 and V30-2, the denomination is ST5W.
ST6	As ST4 but with Viton gaskets.
ST6W	As ST4W but with Viton gaskets.
ST7	Double tandem mechanical seal (not available on V6, V12, V20, V25, V25-2 and V30-2).
ST8	Double back-to-back mechanical seal (not available V6, V12, V20, V25).

2.5 Bushes

V series pumps have two internal bushes, one on the shaft and one on the idler pin. The shaft bush, in which the shaft rotates, runs at a relatively low speed and has low axial load. This bush is not under particular stress and is therefore not subject to excessive wear.

The idler bush, on the other hand, rotates around a pin which must therefore be made from a material harder than that of the bush. It bears the full loads of the delivery pressure and rotates faster than the rotor. This bush, which is therefore subject to greater wear, is easily replaced by removing the cover without having to disconnect the pump from the pipework.

2.6 Construction materials

The materials used to construct V series pumps must be chosen depending on the type of liquid to be pumped, the viscosity, the temperature, the presence or absence of abrasion and chemical agents. The pumps are grouped in versions which cover most of the potential applications. To adapt still further to the liquid to be pumped, it is, however, possible to replace or add components or to vary their construction material.

Component	SP	SPAT ST4WAT ST5WAT ST6WAT	ST4WAW ST5WAW	ST4BS ST5BS	SPG ST4 ST6 ST8	SP1G ST5 ST7 TRMG	SPHT SPHTR	SPK SP1K ST4K TRMK
Casing	GS	SH	SH	GS	GS ①		GS	K
Cover	G	SH	SH	G	G		G	K
Pedestal	G	G	G	G	G		G	G
Rotor	GS	SH	SH	GS	GS		GS	K
Idler	GS	SH	SH	GS	GS		GS	K
Shaft	SH	SH	SH	K9	SH		SH	K9
Idler pin	SH	SH	W	K9	SH		SH	K9
Bushes	B	SH ②	W	GR	G		B	GR
By-pass	G	-	-	G	G		GS	K

B Bronze **GR** Graphite **G** Cast iron **GS** Ductile iron **SH** Hardened steel
K CF8M stainl. steel **K9** AISI 329 stainl. steel **W** Tungsten carbide

① V25-2, V30-2 with tapped ports: cast iron ② Shaft bush: no idler bush fitted

2.7 Options

Options to adapt the pump to the liquid are available. Numerous combinations are possible. The following tables will be of help in choosing which.

Material	V6 V12		V20 V25		V25-2 V30-2		V50-3		V60-2		V70-2		V80-2		V85-2		V90-2		V100-2		V120-2		V150-2		V151		V180		V200	
	G	K	G	K	G	K	G	K	G	K	K	G	K	G	K	G	K	G	K	G	K	G	K	G	K	K	G	K	G	K
Ports position	0°	180°	180°		90°		90°		90°	180°	180°	90°	180°	90°	180°	90°	180°	90°	180°	90°	180°	90°	180°	90°	180°	90°	180°	180°		
+R ①	-	-	-	A	-	B	-	B	-	-	B	-	-	-	B	-	-	-	B	-	-	-	B	-	-	-	-	-	-	
+R1 ①	-	-	-	A	-	A	-	B	-	(B)	B	(B)	(B)	(B)	(B)	(B)	(B)	(B)	(B)	(B)	(B)	(B)	(B)	(B)	(B)	(B)	(B)	(B)	(B)	
+R2 ①	A	A	-	A	-	X	-	A	A	-	A	-	A	-	B	-	B	-	B	-	B	-	B	(B)	(B)	(B)	(B)	(B)		
+R3				C	-	D	-	C-D	-	-	C-D	-	-	-	C-D	-	-	-	-	-	-	-	D	-	-	-	-	-		
+R4				-	D	-	-	-	C-D	C-D	-	C-D	-	-	-	-	-	-	-	-	-	-	-	-	-	-	-	-		
+YR	-	-	-	-	-	-	-	B	-	-	B	-	(B)	-	-	-	-	-	-	-	-	-	-	-	-	-	-			
+YY	-	-	X	-	X	-	X	(X)	(X)	(X)	X	(X)	X	(X)	X	(X)	X	(X)	(X)	(X)	(X)	(X)	(X)	(X)	(X)	(X)	(X)	(X)		

A = Available with tapped ports B = Available with flanged ports C = Available with mechanical seal D = Available with packed gland G = Cast iron version
 K = Stainless steel version X = Available (=) = Non standard. Ask about feasibility and availability

① Maximum operating pressure 10 bar, static test pressure 20 bar

2.8 Drains and flushes

2.8.1 Drains

All sizes of pumps are available with drainage holes on the casing (with the exception of the V6, V12, V20, V25, V25-2F, V30-2F and the versions with option +R) to facilitate the discharge of liquid for maintenance or repair. The sizes of drainage holes depend on the size of pump and the liquid. On request, pumps with larger than standard holes can be supplied (see the following table).

Pump type	Standard	On request
V25-2F, V30-2F	-	1/2"
V50-3	1/4"	1/2"
V60-2	1	1/2"
V60-2, V70-2, V80-2	1/2"	1/2" x 3=11/4"
V80-2, V85-2, V100-2, V120-2, V150-2	2	1/2"
V90-2, V100-2, V150-2, V151	2	1/2"
V180, V200	1"	

The holes are BSP tapped
 1 Only for cast iron version
 2 Only for stainless steel version

2.8.2 Flushes

Flushing of the seal and of the shaft and idler bushes are necessary in the following cases:

- 1) Thermo-setting resins, sugar solutions, polymerizing liquids and liquids which may solidify can block the mechanical seal or the pump.
 - 2) To create a barrier between the liquid and the atmosphere (for example, acids, inflammable and toxic liquids, etc.)
- To reduce these problems, a liquid compatible with the pumped liquid can be sent to the mechanical seal or gland. The flush pressure must be equal to or greater than the delivery pressure. The following table gives the recommended flush capacity in litres per hour for each size of pump.

Pump type	Capacity l/h
V6, V12, V20, V25 *	4
V25-2, V30-2	7
V50-3	15
V60-2	20
V70-2, V80-2, V85-2	30
V90-2, V100-2	40
V120-2, V150-2, V151	50
V180, V200	60

* Only the mechanical seal version can be flushed
 The idler pin of the V200 can also be flushed with a capacity of 60 l/hr

3 Performance

The performance of V series pumps depends on the rotation speed and the viscosity. It is therefore necessary to refer to these physical quantities to have a fairly accurate idea of the performance of a pump.

Since the pumps are mounted with clearances between several components, actual performance can vary up to 20% from the nominal capacity because of "slip" (the capacity lost because of liquid returning to the suction port between the gear faces and the cover). The data in the following table have been found by experiment and are average values for a certain number of pumps. They refer to various viscosity values; for intermediate viscosities, it is necessary to interpolate.

The table shows the value of the slip capacity q in litres per minute for each bar of differential pressure at certain values of the viscosity. To obtain the average value of slip, the values in the table must be multiplied by rotation speed and the differential pressure. The average actual capacity is given by:

$$Q = Cyl \times N - q \cdot P$$

where:

Q = Actual capacity in l/min

Cyl = Unit displacement in litres

N = RPM

q = Slip capacity in litres/min.bar

P = Differential pressure between suction and discharge

The calculation of the power required is more complex: see the detailed performance curves for each pump.

Example of capacity calculation.

Pump type : V 50-3

Viscosity : 200 cst

Differential pressure : 4 bar

Speed : 960 RPM

The value of the slip capacity (q) is as follow. The table shows a slip of 1.28 l/min.bar for the V 50-3 at 200cst. Substituting these values in the equation for the calculation of the actual capacity (Q) we obtain:

$$Q = 0,230 \times 960 - (1,28 \times 4) = 216 \text{ l/min.}$$

Pump type	Capacity l/revolution	Viscosity mm ² /s (cSt)							
		20	60	200	600	2000	6000	20.000	60.000
V6	0,0045	0.06	0.052	0.04	0.03	0.023	0.019	0.012	—
V12	0,0085	0.2	0.15	0.10	0.05	0.027	0.02	0.015	—
V20	0,0214	0.4	0.30	0.12	0.06	0.030	0.022	0.018	—
V25	0,036	0.5	0.40	0.20	0.10	0.07	0.05	0.025	—
V25-2	0,045	0.62	0.50	0.38	0.17	0.128	0.09	0.03	0.01
V30-2	0,082	0.89	0.70	0.53	0.38	0.23	0.11	0.03	0.01
V50-3	0,230	2.11	1.72	1.28	0.95	0.59	0.33	0.11	0.04
V60-2	0,500	3.46	2.92	2.39	1.76	1.16	0.66	0.28	0.09
V70-2	0,800	5.00	4.24	3.40	2.64	1.76	1.16	0.52	0.16
V80-2	1,200	6.60	5.58	4.56	3.36	2.22	1.26	0.54	0.18
V85-2	1,600	7.20	6.24	4.64	3.44	2.16	1.2	—	—
V90-2	2,200	11.00	15.40	7.48	5.80	3.87	2.55	1.14	0.35
V100-2	3,200	17.66	15.10	12.28	9.72	6.78	4.48	2.04	0.64
V120-2	6,500	31.73	27.02	22.11	17.40	12.28	8.19	3.89	1.22
V150-2	7,800	41.52	35.38	28.70	22.85	16.21	10.81	5.40	1.72
V151	6,500	31.73	27.02	22.11	17.40	12.28	8.19	3.89	1.22
V180	12,400	80.00	68.50	55.60	44.20	31.20	18.20	10.00	3.10
V200	16,700	80.76	68.60	55.57	44.28	31.26	19.54	9.98	3.47

Performance

Type	Displacement l/revolution	Viscosity mm ² /s (cSt)	RPM	Pressure (bar)				
				2	4	8	12	16
				Power (kW) / Capacity (l/min)				
V6	0,0045	20	1800	0.21 / 8	0.25 / 8	0.30 / 7.8	0.36 / 7.7	—
		60	1800	0.25 / 8	0.29 / 8	0.35 / 7.8	0.40 / 7.8	—
		200	1800	0.30 / 8	0.34 / 8	0.40 / 7.9	0.46 / 7.8	0.52 / 7.7
		600	1800	0.40 / 8	0.44 / 8	0.50 / 7.9	0.57 / 7.9	0.63 / 7.8
		2000	1100	0.23 / 4.9	0.25 / 4.9	0.29 / 4.8	0.33 / 4.8	0.37 / 4.8
		6000	1100	0.30 / 4.9	0.33 / 4.9	0.38 / 4.9	0.42 / 4.9	0.45 / 4.9
		20000	700	0.19 / 3.1	0.20 / 3.1	0.23 / 3.1	0.26 / 3.1	0.28 / 3.1
		V12	0,0085	20	1800	0.25 / 14.8	0.30 / 14.5	0.40 / 14
60	1800			0.28 / 14.8	0.30 / 14.5	0.40 / 14	0.50 / 13.9	—
200	1800			0.38 / 14.8	0.44 / 14.8	0.55 / 14.2	0.65 / 14	0.76 / 13.9
600	1800			0.50 / 14.8	0.56 / 14.8	0.68 / 14.5	0.80 / 14.3	0.90 / 14.1
2000	1100			0.30 / 9	0.30 / 9	0.40 / 9	0.47 / 8.9	0.53 / 8.8
6000	1100			0.40 / 9	0.40 / 9	0.50 / 9	0.57 / 9	0.60 / 9
20000	700			0.24 / 5.8	0.27 / 5.7	0.31 / 5.7	0.36 / 5.7	0.40 / 5.7
V20	0,0214			20	1800	0.27 / 36.2	0.45 / 36	0.73 / 35
		60	1800	0.40 / 36.2	0.70 / 36	0.85 / 35	1.10 / 34.5	—
		200	1800	0.46 / 36.2	0.73 / 36	1.00 / 35	1.28 / 34.5	1.54 / 34
		600	1800	0.88 / 38.5	1.10 / 38.2	1.20 / 37.7	1.40 / 37.4	1.70 / 37
		2000	1100	0.58 / 22.6	0.69 / 22.4	0.84 / 22	1.00 / 21.7	1.17 / 21.5
		6000	1100	1.00 / 23.4	1.10 / 23.2	1.25 / 22.8	1.39 / 22.4	1.54 / 22
		20000	700	0.58 / 14.5	0.73 / 14.3	0.80 / 13.9	0.88 / 13.5	0.97 / 13.2
		V25	0,036	20	1800	0.60 / 62.3	0.86 / 61.8	1.47 / 60.5
60	1800			0.70 / 62.3	1.00 / 61.8	1.70 / 60.7	2.20 / 59.5	—
200	1800			1.00 / 62.3	1.32 / 51.8	1.14 / 60.7	2.50 / 59.5	3.20 / 59
600	1800			1.50 / 62.5	1.80 / 62	2.20 / 61.2	2.60 / 60.6	3.30 / 60
2000	1100			1.18 / 39.3	1.47 / 39	1.76 / 38.7	2.00 / 38.4	2.35 / 38.2
6000	1100			1.57 / 40	1.85 / 39.8	2.20 / 39.4	2.50 / 39	2.80 / 38.6
20000	700			1.32 / 24.9	1.47 / 24.7	1.50 / 24.5	1.81 / 24.3	2.10 / 24.2
V25-2	0,045			20	1450	1.1 / 64	1.4 / 63	1.8 / 60
		60	1450	1.3 / 64	1.5 / 63	2.0 / 61	2.5 / 59	—
		200	1450	1.7 / 65	1.9 / 64	2.4 / 62	2.8 / 61	3.4 / 59
		600	1300	2.0 / 58	2.3 / 58	2.7 / 56	3.2 / 55	3.6 / 54
		2000	1100	2.1 / 50	2.3 / 49	2.7 / 48	3.1 / 48	3.5 / 47
		6000	900	2.2 / 40	2.5 / 40	2.8 / 40	3.1 / 39	3.4 / 39
		20000	680	2.2 / 31	2.2 / 31	2.5 / 30	2.7 / 30	3.0 / 30
		60000	525	1.7 / 23	1.8 / 23	2.1 / 23	2.4 / 23	2.6 / 23

Do not install pumps at speeds faster than those in the table.

Performance								
Type	Displacement litres/revol.	Viscosity mm ² /s (cSt)	RPM	Pressure (bar)				
				2	4	8	12	16
Power (kW) / Capacity (l/min)								
V30-2	0,082	20	1450	1.2 / 117	1.6 / 115	2.4 / 111	3.2 / 108	—
		60	1450	1.3 / 118	1.7 / 116	2.6 / 113	3.4 / 111	—
		200	1450	1.4 / 118	1.9 / 117	2.7 / 115	3.5 / 113	4.3 / 110
		600	1300	1.8 / 106	2.2 / 105	2.9 / 104	3.6 / 102	4.4 / 101
		2000	1100	2.0 / 90	2.4 / 89	3.1 / 88	3.7 / 87	4.3 / 87
		6000	900	2.1 / 74	2.5 / 73	3.0 / 73	3.6 / 73	4.1 / 72
		20000	680	2.1 / 56	2.4 / 56	2.8 / 56	3.2 / 55	3.6 / 55
		60000	525	2.0 / 43	2.2 / 43	2.6 / 43	2.8 / 43	3.2 / 43
V50-3	0,230	20	960	1.5 / 217	2.2 / 212	3.7 / 204	5.1 / 196	—
		60	960	1.8 / 217	2.6 / 214	4.0 / 207	5.5 / 200	—
		200	960	2.3 / 218	3.1 / 216	4.6 / 211	6.1 / 205	7.6 / 200
		600	870	2.6 / 198	3.3 / 196	4.7 / 192	6.0 / 188	7.4 / 185
		2000	720	2.6 / 164	3.2 / 163	4.4 / 161	5.5 / 159	6.6 / 156
		6000	600	2.6 / 137	3.2 / 137	4.1 / 135	5.1 / 134	6.0 / 133
		20000	450	2.3 / 103	2.7 / 103	3.5 / 103	4.2 / 102	5.0 / 102
		60000	350	2.0 / 80	2.3 / 80	2.9 / 80	3.5 / 80	4.0 / 180
V60-2	0,500	20	750	3.0 / 368	4.3 / 361	6.9 / 347	9.2 / 334	—
		60	720	3.3 / 354	4.5 / 348	7.0 / 337	9.4 / 325	—
		200	630	3.5 / 310	4.6 / 305	6.8 / 296	8.9 / 286	11.0 / 277
		600	550	3.7 / 272	4.8 / 268	6.6 / 261	8.5 / 254	10.4 / 247
		2000	450	3.6 / 223	4.5 / 220	6.0 / 216	7.6 / 211	9.1 / 206
		6000	380	3.6 / 189	4.2 / 187	5.6 / 185	6.9 / 182	8.2 / 179
		20000	280	2.9 / 139	3.4 / 139	4.5 / 138	5.4 / 137	6.4 / 136
		60000	220	2.5 / 110	2.9 / 110	3.7 / 109	4.5 / 109	5.2 / 109
V70-2	0,800	20	600	3.5 / 470	5.1 / 460	8.3 / 440	11.5 / 420	—
		60	600	3.7 / 472	5.4 / 463	8.6 / 446	11.8 / 429	—
		200	550	4.2 / 433	5.7 / 426	8.7 / 413	11.6 / 399	14.5 / 386
		600	480	4.5 / 379	6.0 / 373	8.5 / 363	11.0 / 352	13.7 / 342
		2000	400	5.0 / 317	6.2 / 313	8.5 / 306	10.7 / 299	13.0 / 292
		6000	330	5.2 / 262	6.2 / 259	8.1 / 255	10.0 / 250	11.8 / 245
		20000	250	5.1 / 199	6.0 / 198	7.5 / 196	8.9 / 194	10.2 / 192
		60000	190	4.8 / 152	5.5 / 151	6.7 / 151	7.8 / 150	8.9 / 149
V80-2	1,200	20	600	4.5 / 707	7.0 / 694	11.8 / 667	16.6 / 641	—
		60	600	4.9 / 709	7.3 / 698	12.1 / 675	16.9 / 653	—
		200	550	5.4 / 651	7.7 / 642	12.0 / 624	16.5 / 605	21.0 / 587
		600	480	6.0 / 569	7.9 / 563	12.0 / 549	16.0 / 536	19.6 / 522
		2000	400	6.4 / 476	8.0 / 471	11.4 / 462	14.7 / 453	18.0 / 445
		6000	330	6.5 / 393	8.0 / 391	11.0 / 386	13.5 / 381	16.2 / 376
		20000	250	6.3 / 299	7.5 / 298	9.6 / 296	11.7 / 294	13.8 / 291
		60000	190	5.8 / 228	6.7 / 227	8.3 / 227	10.0 / 226	11.5 / 225

Do not install pumps at speeds faster than those in the table.

Performance

Type	Displacement litres/revol.	Viscosity mm ² /s (cSt)	RPM	Pressure (bar)				
				2	4	8	12	16
				Power (kW) / Capacity (l/min)				
V85-2	1,600	20	600	5.7 / 945	8.9 / 930	15.3 / 902	21.7 / 873	—
		60	600	6.2 / 947	9.4 / 935	15.8 / 910	22.2 / 885	—
		200	550	9.2 / 873	12.3 / 866	18.3 / 852	24.2 / 833	—
		600	480	7.5 / 761	10.2 / 754	15.4 / 740	20.5 / 726	—
		2000	400	7.9 / 635	10.2 / 631	14.7 / 622	19.0 / 614	—
		6000	335	8.5 / 533	10.5 / 531	14.2 / 526	18.0 / 521	—
V90-2	2,200	20	430	5.6 / 924	8.8 / 902	15.0 / 858	21.4 / 814	—
		60	430	6.0 / 927	9.0 / 909	15.0 / 871	21.6 / 834	—
		200	390	6.3 / 843	9.3 / 828	15.0 / 798	20.7 / 768	—
		600	340	7.0 / 736	10.0 / 725	15.0 / 702	19.7 / 678	—
		2000	280	7.9 / 608	10.0 / 600	14.3 / 585	18.5 / 570	—
		6000	230	8.5 / 500	10.4 / 496	14.0 / 486	17.6 / 475	—
		20000	175	8.5 / 383	10.0 / 380	13.0 / 376	15.5 / 371	—
		60000	135	8.3 / 296	9.7 / 296	12.0 / 294	14.1 / 293	—
						Pressure (bar)		
				2	4	8	12	
				Power (kW) / Capacity (l/min)				
V100-2	3,200	20	430	8.0 / 1341	13.0 / 1306	22.0 / 1235	31.0 / 1165	
		60	430	8.5 / 1346	13.0 / 1316	22.0 / 1255	31.3 / 1195	
		200	390	8.8 / 1223	13.0 / 1199	21.0 / 1150	29.6 / 1100	
		600	340	10.0 / 1069	14.0 / 1049	21.0 / 1010	28.3 / 971	
		2000	280	11.0 / 882	14.0 / 869	20.3 / 842	20.6 / 815	
		6000	230	11.5 / 727	14.2 / 718	19.4 / 700	24.4 / 682	
		20000	175	11.6 / 556	13.7 / 552	18.0 / 544	21.7 / 536	
		60000	135	11.5 / 431	13.0 / 429	16.5 / 427	19.5 / 424	

Do not install pumps at speeds faster than those in the table.

Performance							
Type	Displacement litres/revol.	Viscosity mm ² /s (cSt)	RPM	Pressure (bar)			
				2	4	6	8
Power (kW) / Capacity (l/min)							
V120-2	3,200	20	315	12.0 / 1984	19.0 / 1921	26.0 / 1857	33.0 / 1794
		60	315	13.0 / 1994	20.0 / 1940	26.4 / 1886	33.2 / 1832
		200	280	11.5 / 1776	17.6 / 1732	23.7 / 1687	30.0 / 1643
		600	245	12.0 / 1558	17.0 / 1523	22.0 / 1886	28.0 / 1435
		2000	200	12.0 / 1275	16.0 / 1251	21.0 / 1226	25.0 / 1201
		6000	170	13.0 / 1072	17.0 / 1072	21.0 / 1056	24.0 / 1040
		20000	125	11.7 / 805	14.7 / 797	17.6 / 789	20.5 / 781
		60000	100	12.3 / 648	15.0 / 645	17.2 / 643	19.5 / 640
V150-2	7,800	20	315	15.0 / 2374	23.0 / 2291	31.5 / 2208	40.0 / 2125
		60	315	15.5 / 2386	24.0 / 2315	32.0 / 2245	40.0 / 2174
		200	280	14.0 / 2127	21.0 / 2069	28.6 / 2012	36.0 / 1954
		600	245	14.0 / 1865	21.0 / 1820	27.0 / 1774	33.5 / 1729
		2000	200	14.6 / 1528	20.0 / 1496	25.0 / 1464	30.6 / 1432
		6000	170	16.0 / 1304	20.6 / 1283	25.0 / 1261	30.0 / 1240
		20000	125	14.6 / 964	18.2 / 953	21.6 / 943	25.0 / 932
		60000	100	15.0 / 777	18.0 / 773	21.0 / 770	24.0 / 766
V151	3,200	20	315	12.0 / 1984	19.0 / 1921	26.0 / 1857	33.0 / 1794
		60	315	13.0 / 1994	20.0 / 1940	26.4 / 1886	33.2 / 1832
		200	280	11.5 / 1776	17.6 / 1732	23.7 / 1687	30.0 / 1643
		600	245	12.0 / 1558	17.0 / 1523	22.0 / 1886	28.0 / 1435
		2000	200	12.0 / 1275	16.0 / 1251	21.0 / 1226	25.0 / 1201
		6000	170	13.0 / 1072	17.0 / 1072	21.0 / 1056	24.0 / 1040
		20000	125	11.7 / 805	14.7 / 797	17.6 / 789	20.5 / 781
		60000	100	12.3 / 648	15.0 / 645	17.2 / 643	19.5 / 640
V180	12,400	20	245	12.0 / 2850	22.0 / 2700	32.0 / 2560	42.0 / 2400
		60	245	13.0 / 2900	23.0 / 2760	33.0 / 2620	43.0 / 2490
		200	220	20.0 / 2600	30.0 / 2500	40.0 / 2390	50.0 / 2280
		600	220	23.0 / 2640	33.0 / 2550	43.0 / 2460	53.0 / 2380
		2000	160	22.0 / 1900	30.0 / 1860	38.0 / 1790	44.0 / 1730
		6000	130	23.0 / 1570	29.0 / 1535	34.0 / 1495	40.0 / 1460
		20000		26.0 / 1340	31.0 / 1321	36.0 / 1300	41.0 / 1270
		60000		24.0 / 1045	28.0 / 1040	32.0 / 1035	36.0 / 1030
V200	16,700	20	250	24.0 / 4014	38.0 / 3852	52.0 / 3690	66.0 / 3529
		60	250	26.0 / 4038	40.0 / 3900	54.0 / 3763	68.0 / 3626
		200	225	25.0 / 3646	37.5 / 3535	50.0 / 3424	62.5 / 3313
		600	195	25.5 / 3168	37.0 / 3079	48.0 / 2990	58.6 / 2900
		2000	160	25.5 / 2607	35.0 / 2547	44.0 / 2485	53.0 / 2422
		6000	135	26.5 / 2216	34.6 / 2177	42.0 / 2138	50.0 / 2100
		20000	112	28.0 / 1850	35.0 / 1830	41.5 / 1810	48.0 / 1790
		60000	85	25.0 / 1413	36.0 / 1405	35.7 / 1400	40.6 / 1392

Do not install pumps at speeds faster than those in the table.

4 Drives

V series pumps can be supplied with electric motor (TEFC or explosion proof), internal combustion engines (petrol or diesel), or water, hydraulic or air motors. They can also be driven by the power take off of a motor vehicle. The V6, V12, V20, V25, V 25-2, V 30-2 and V 50-3 can be directly coupled to 4, 6 or 8 pole electric motors. The following illustrations show some typical drives.

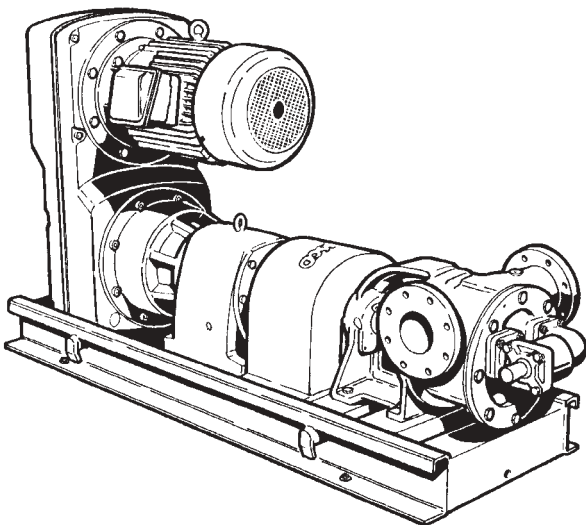
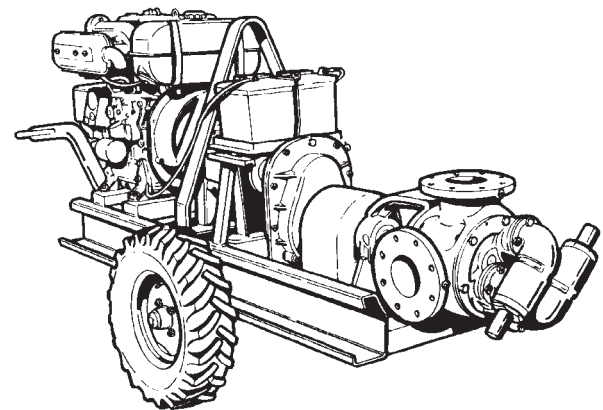
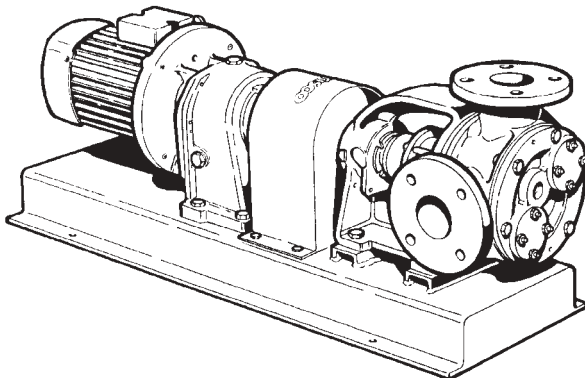
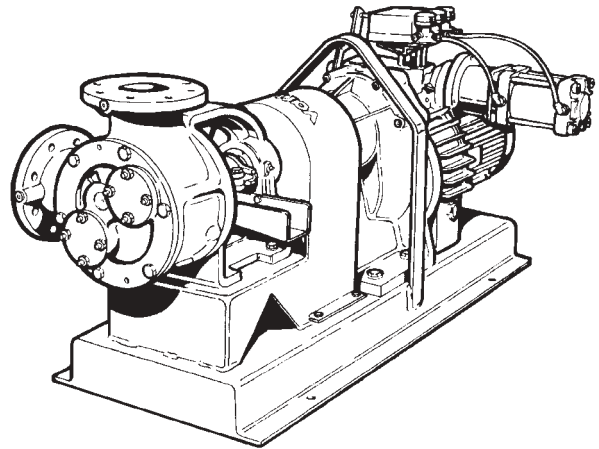
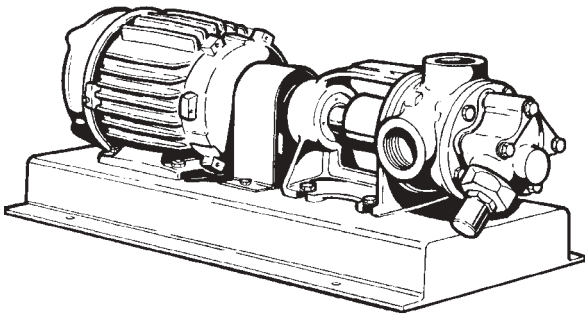

Description

- 1 Pump with tapped ports and direct electric motor drive
- 2 Pump with electric motor and gear box drive
- 3 Pump with gear/belt variable speed drive
- 4 Pump with variable speed gear drive with pneumatic control
- 5 Pump with double by-pass coupled to diesel engine on trailer

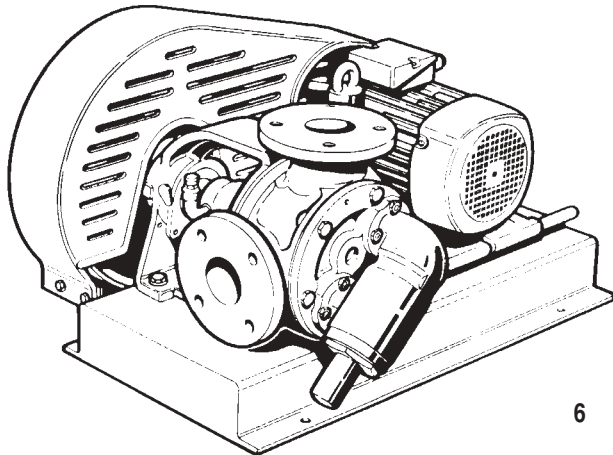

6

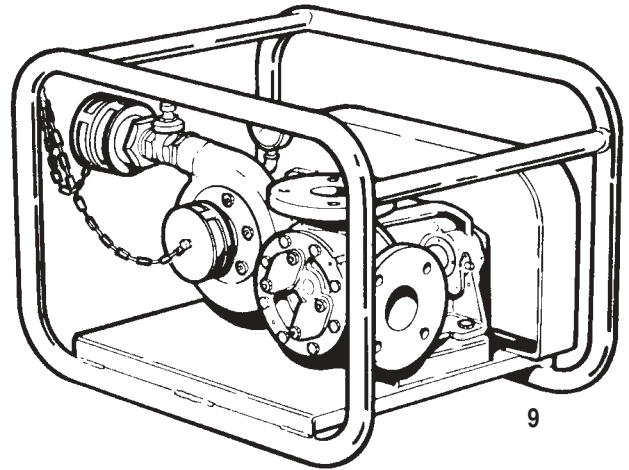

9

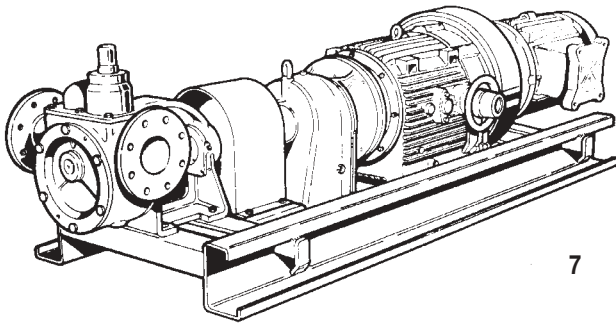

7

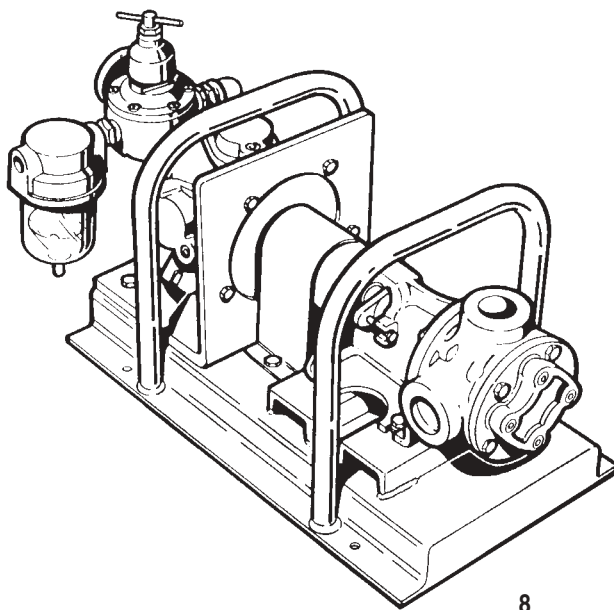

8

Description

- 6 Pump with V-belt drive
- 7 Pump with variable speed gear drive with manual control
- 8 Pump with tapped ports directly driven by air motor
- 9 Emergency pump unit coupled with V-belts to a water turbine

Performance curves



Viscosity range: from 20 to 600 mm²/s
 Displacement: 0,0045 litres

Viscosity: 20 mm²/s (cSt)

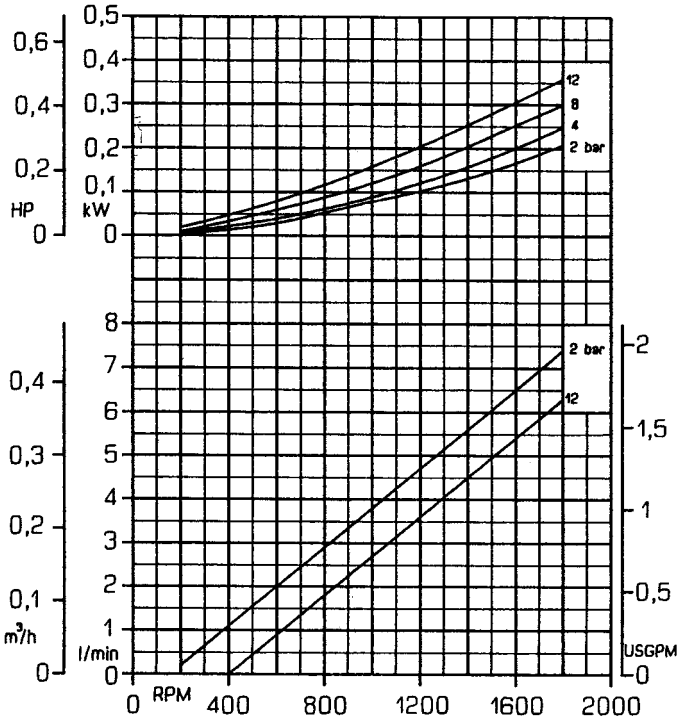

Viscosity: 60 mm²/s (cSt)

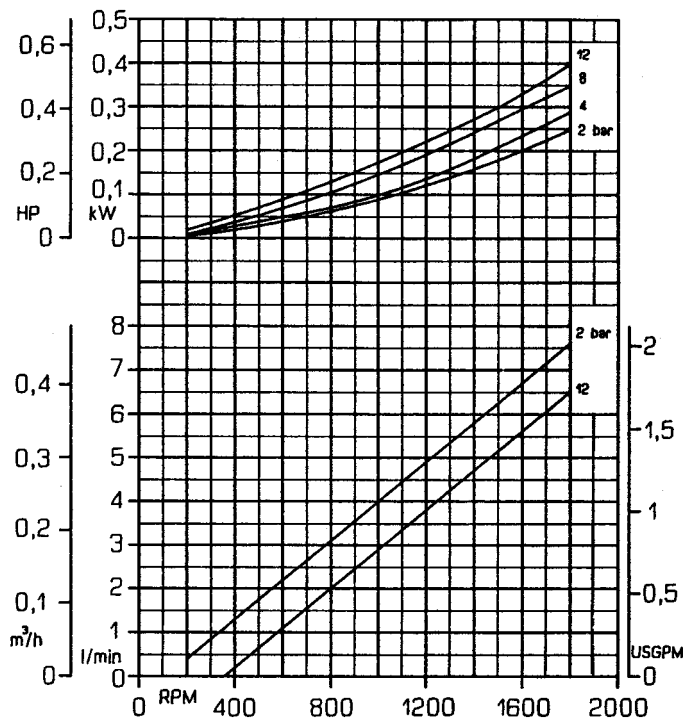

Viscosity: 200 mm²/s (cSt)

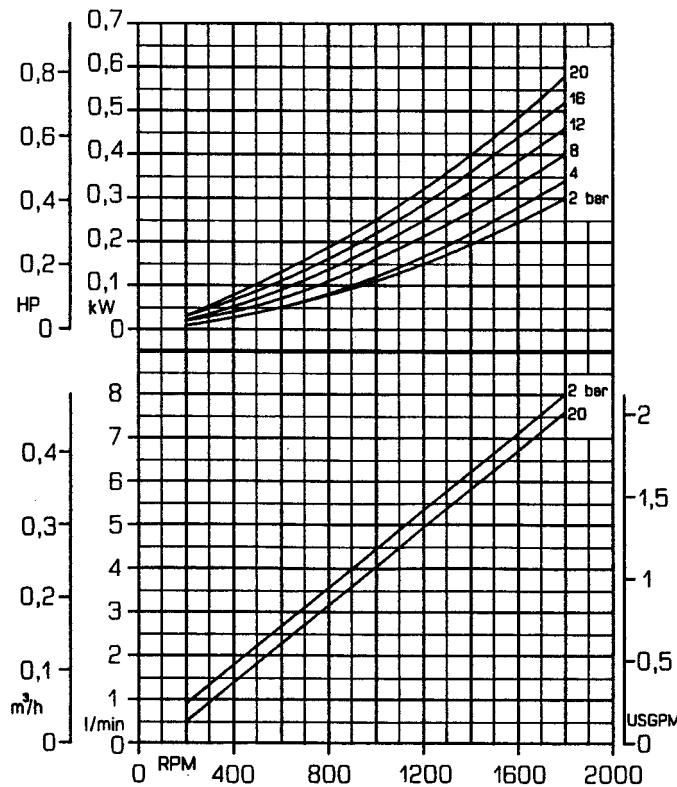

Viscosity: 600 mm²/s (cSt)

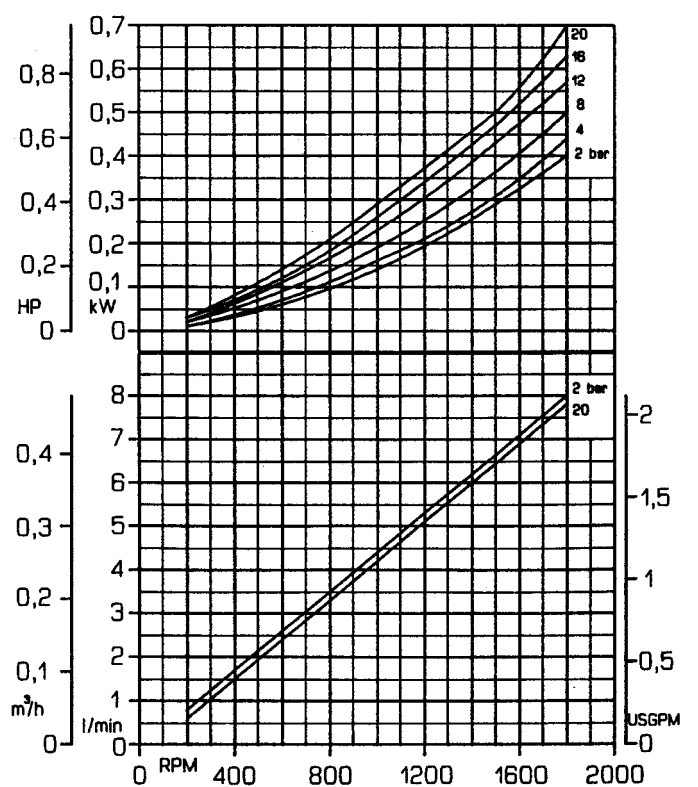

Viscosity: 2000 mm²/s (cSt)

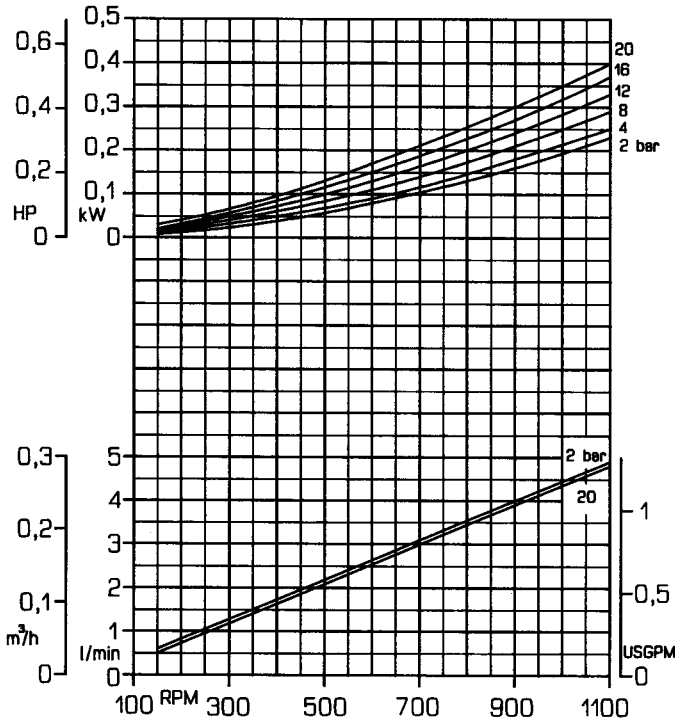

Viscosity: 6000 mm²/s (cSt)

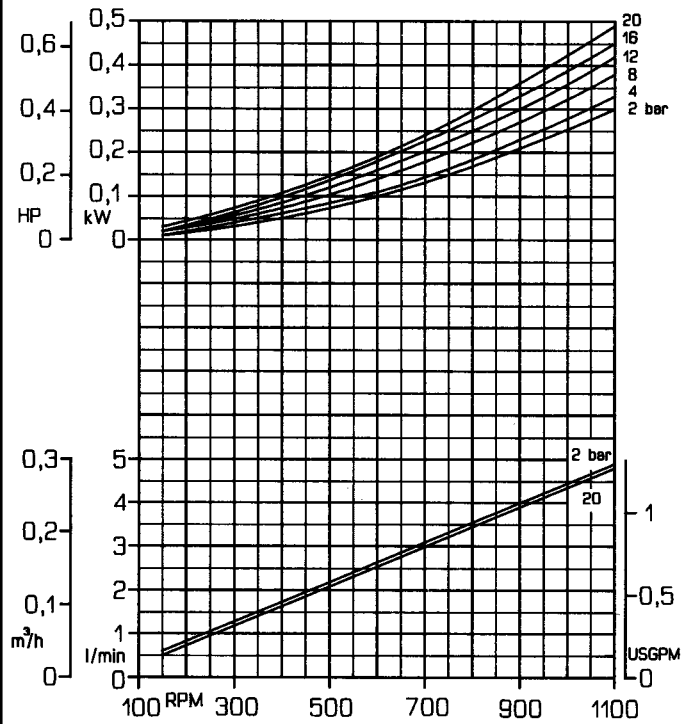

Viscosity: 20000 mm²/s (cSt)

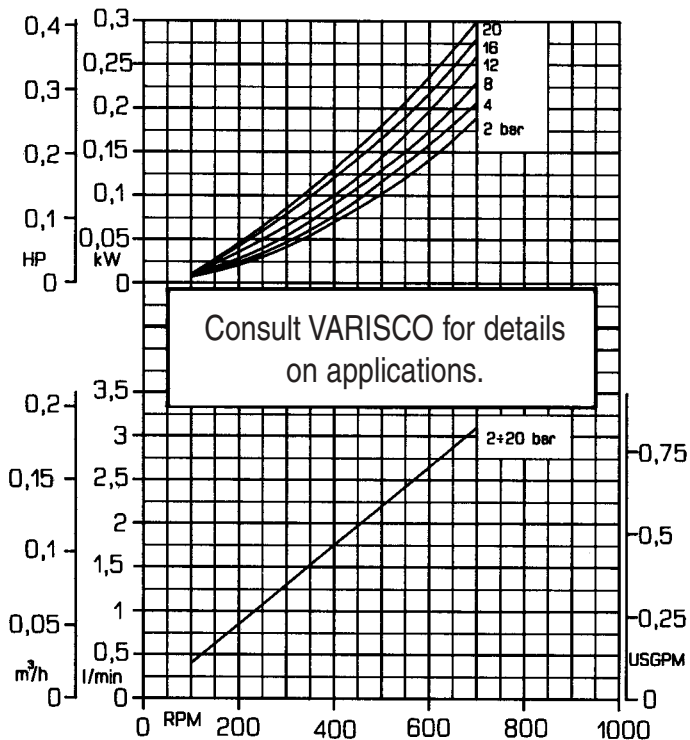

Viscosity: 60000 mm²/s (cSt)

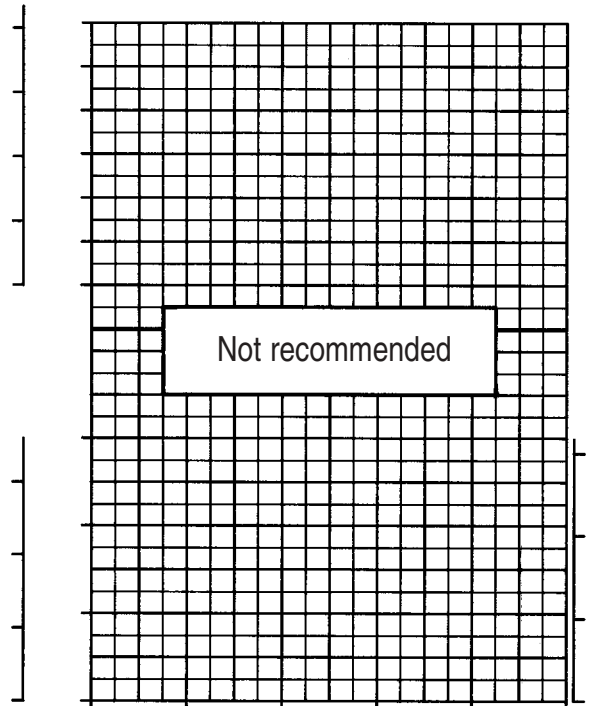

Performance curves



Viscosity range: from 20 to 600 mm²/s
 Displacement: 0,0085 litres

Viscosity: 20 mm²/s (cSt)

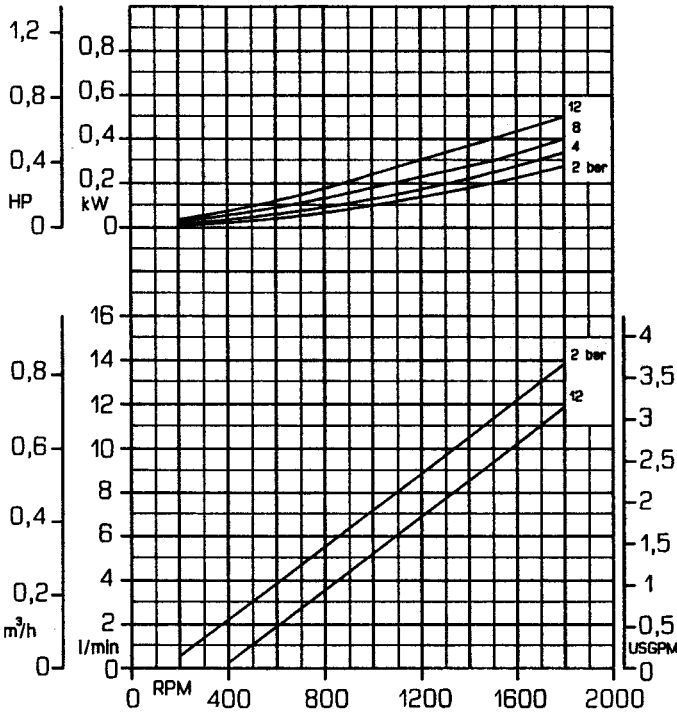

Viscosity: 60 mm²/s (cSt)

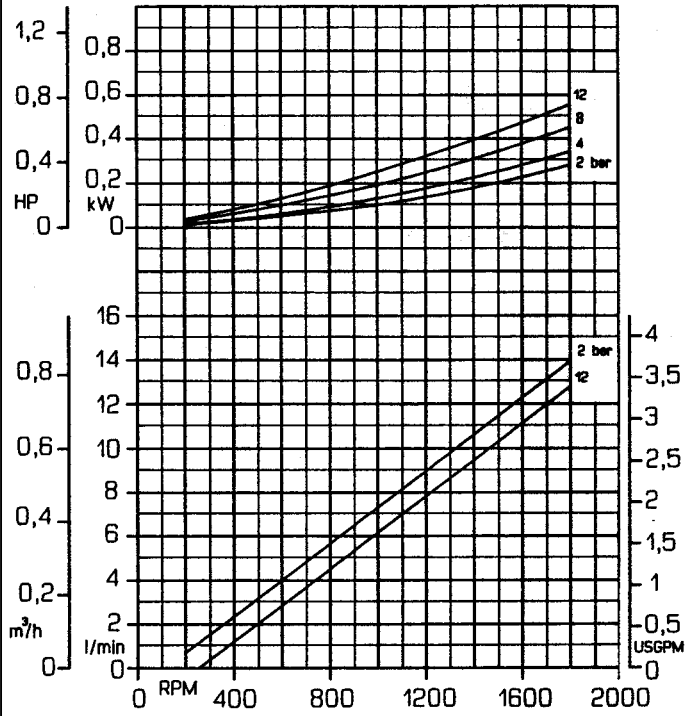

Viscosity: 200 mm²/s (cSt)

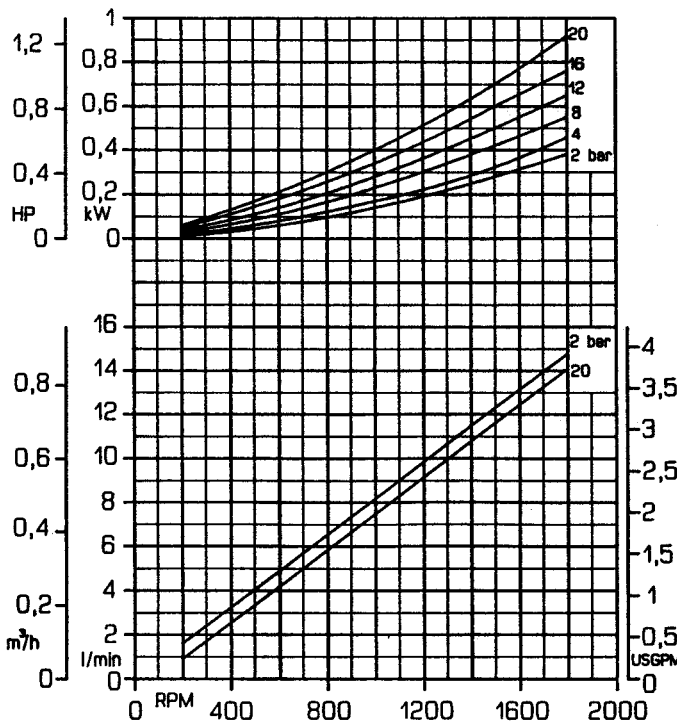

Viscosity: 600 mm²/s (cSt)

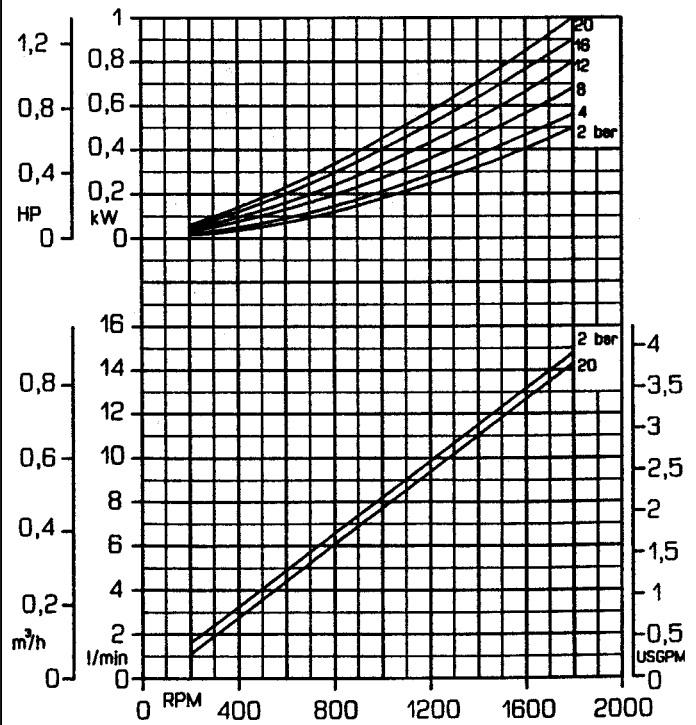

Viscosity: 2000 mm²/s (cSt)

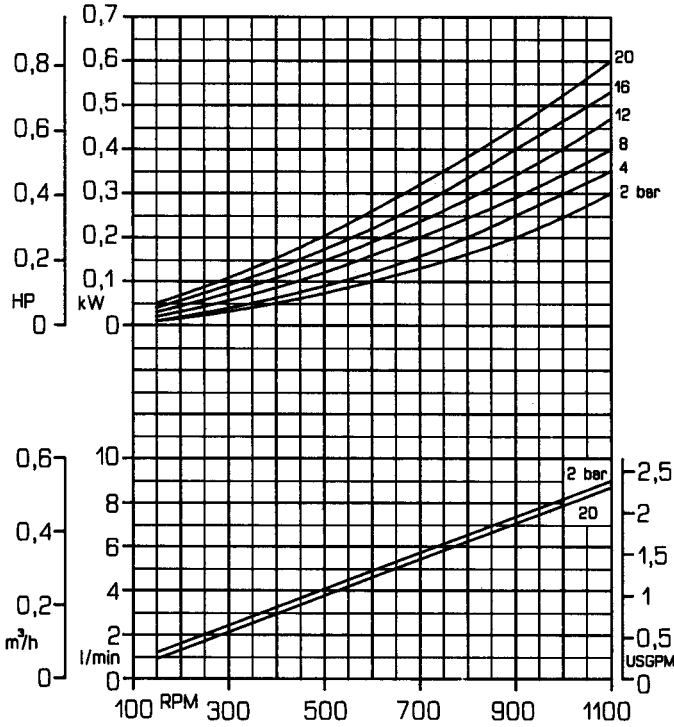

Viscosity: 6000 mm²/s (cSt)

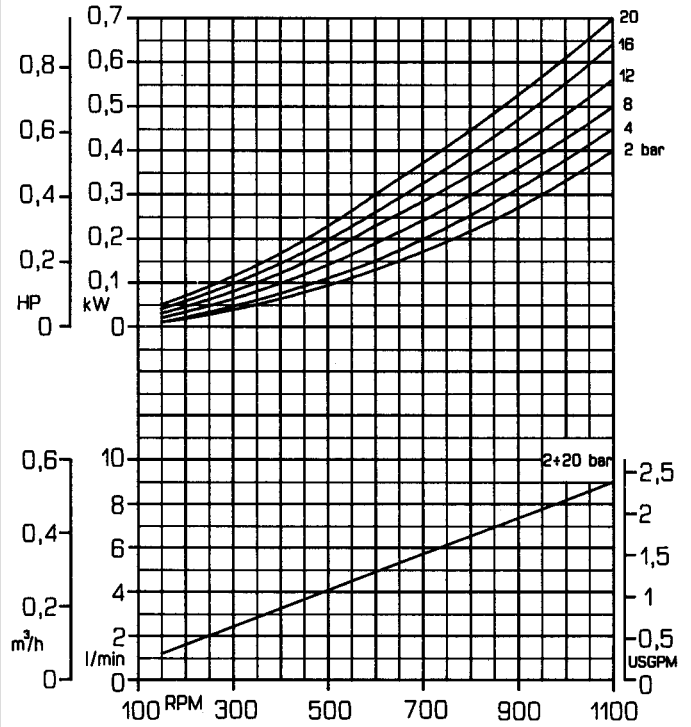

Viscosity: 20000 mm²/s (cSt)

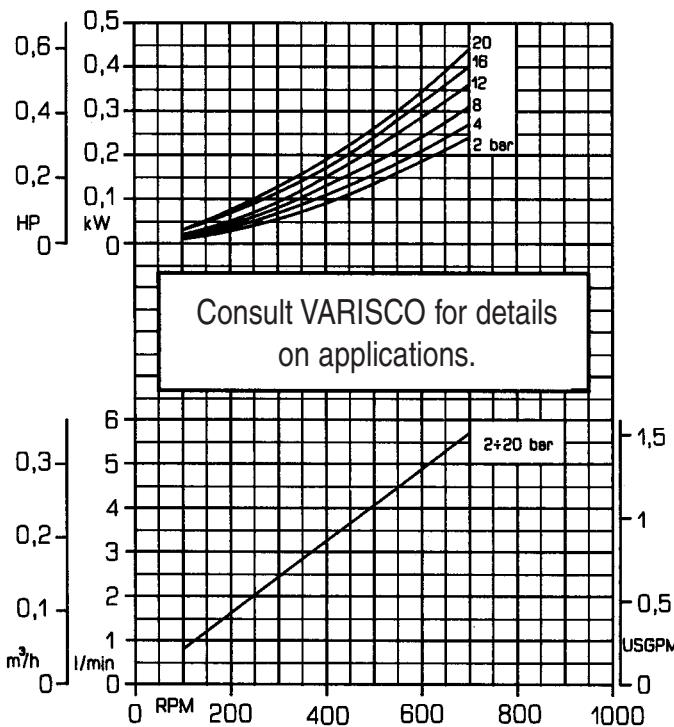

Viscosity: 60000 mm²/s (cSt)

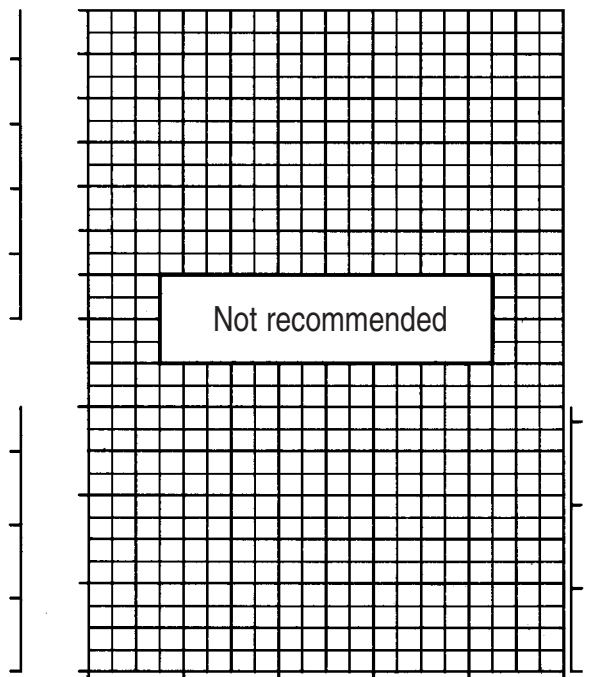

V20

Pag. 20 / 57

04 11 - Rev. 00

Performance curves

Viscosity range: from 20 to 600 mm²/s
Displacement: 0,0214 litres



Viscosity: 20 mm²/s (cSt)

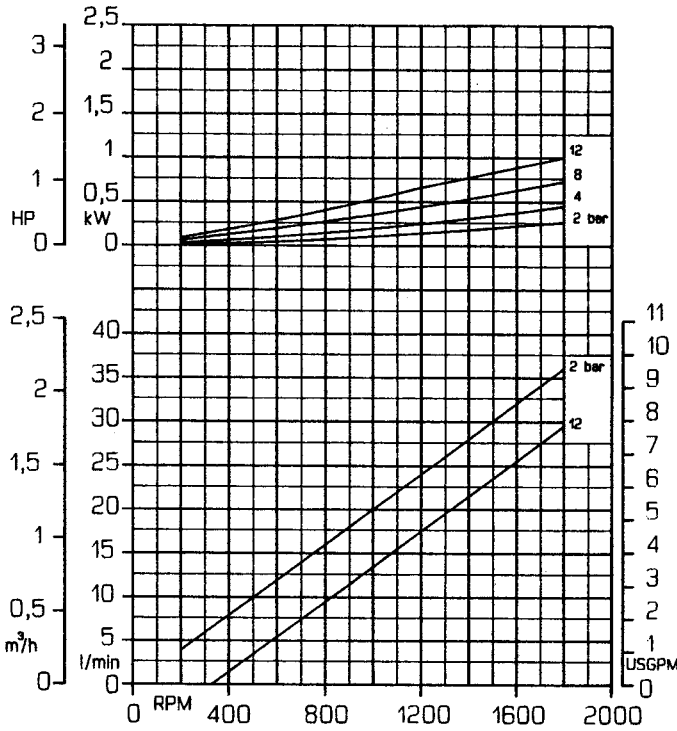

Viscosity: 60 mm²/s (cSt)

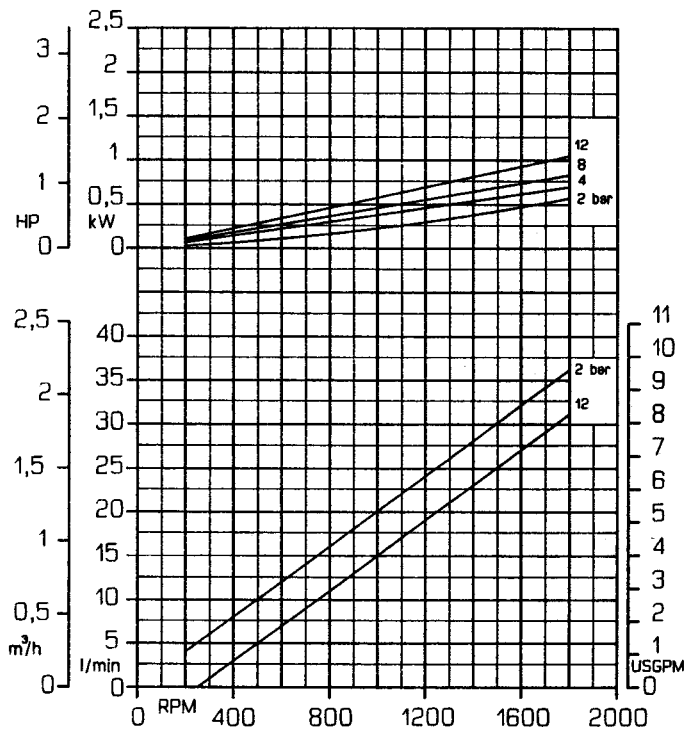

Viscosity: 200 mm²/s (cSt)

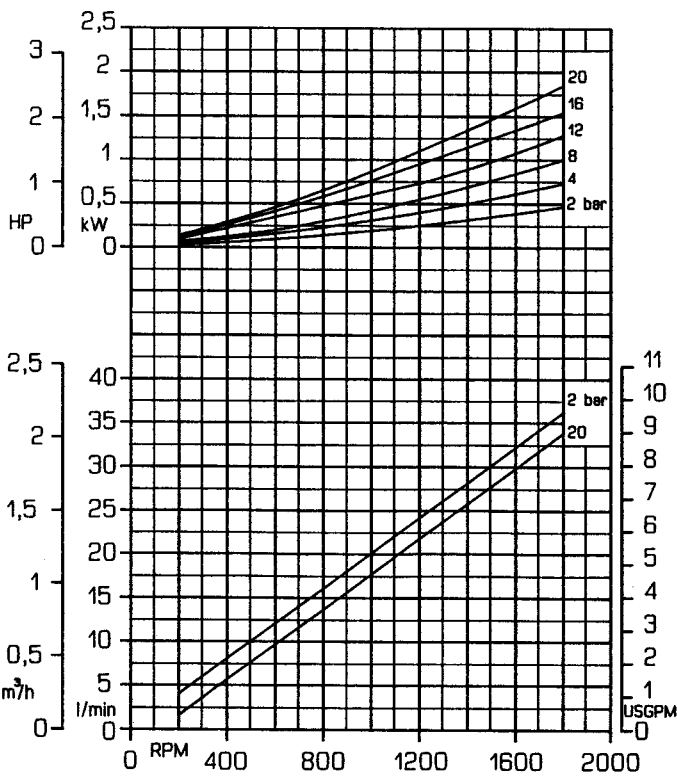

Viscosity: 600 mm²/s (cSt)

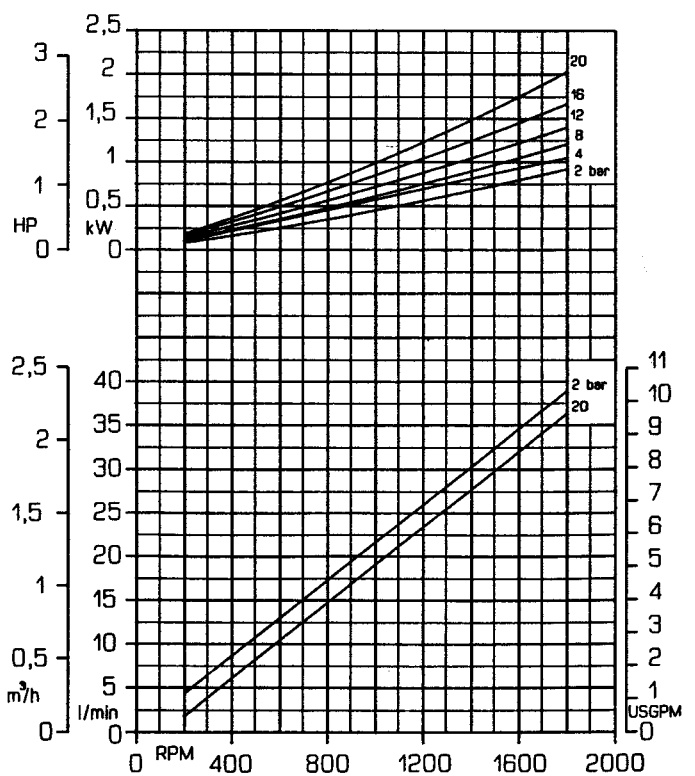

Viscosity: 2000 mm²/s

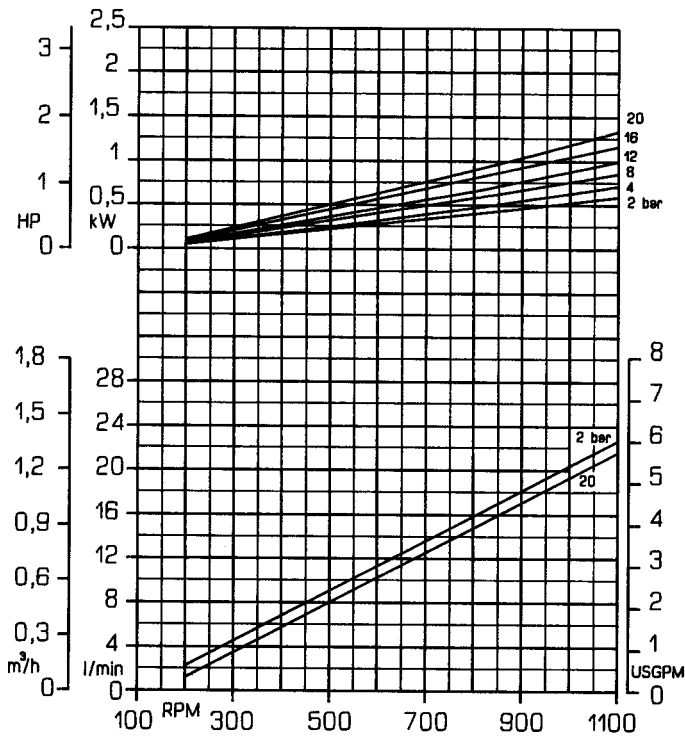

Viscosity: 6000 mm²/s

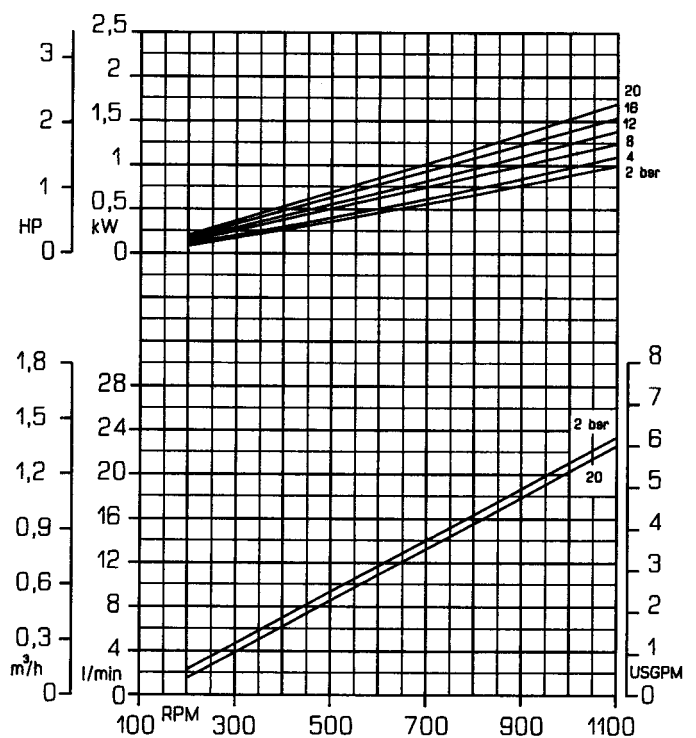

Viscosity: 20000 mm²/s

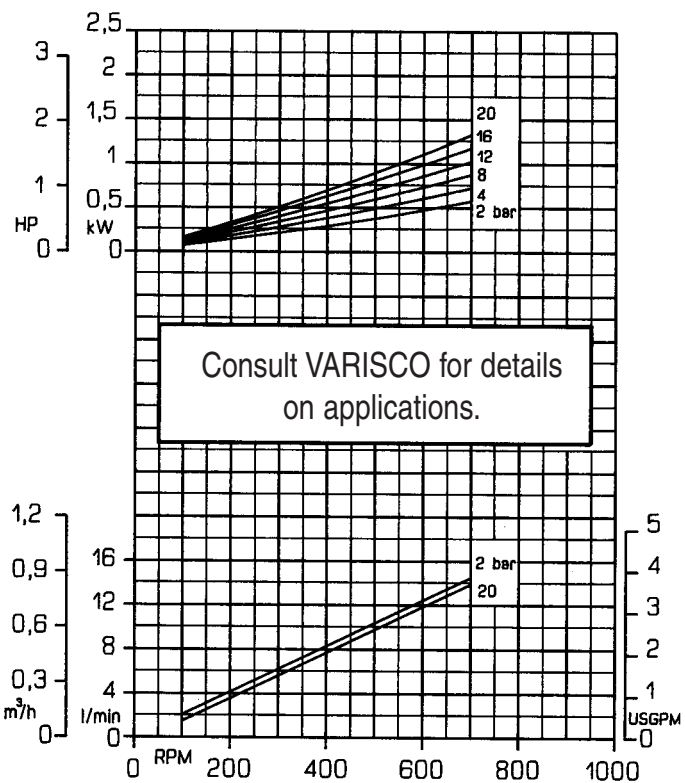

Viscosity: 60000 mm²/s

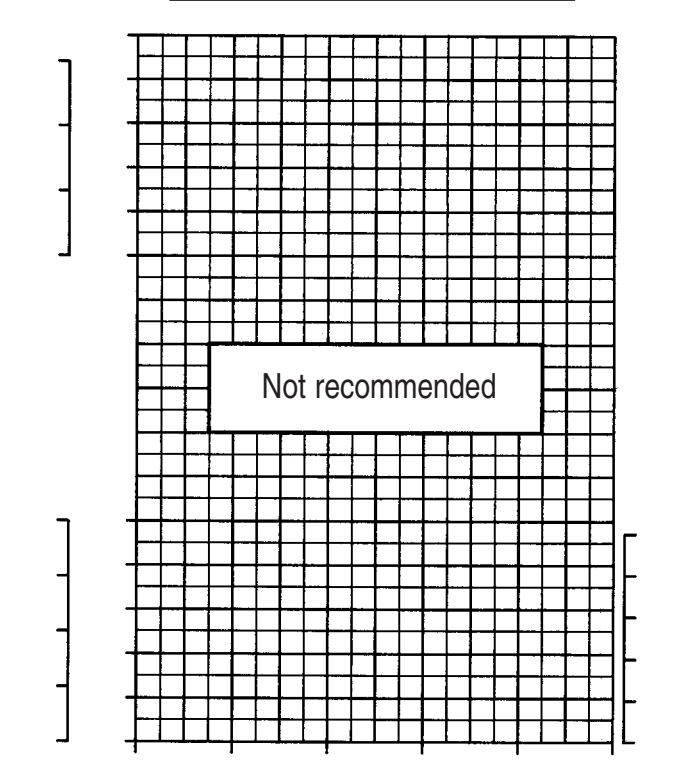

Performance curves



Viscosity range: from 20 to 600 mm²/s
 Displacement: 0,036 litres

Viscosity: 20 mm²/s (cSt)

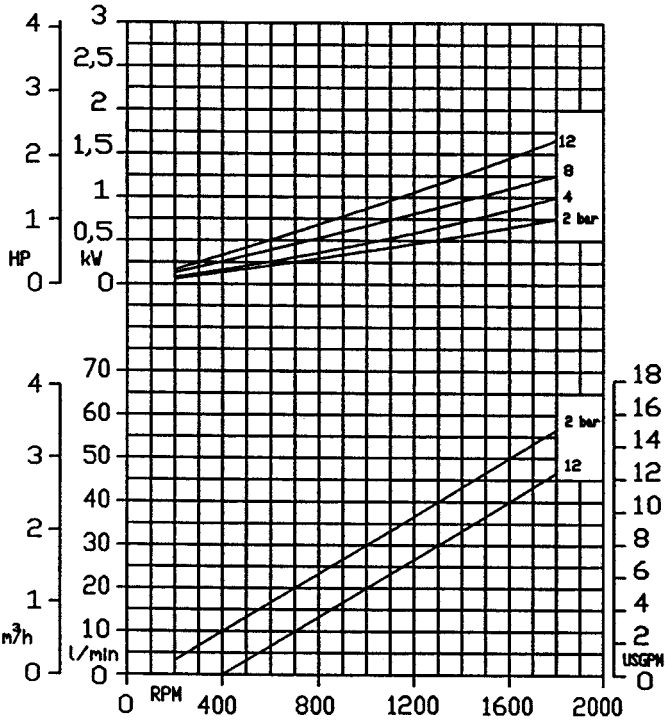

Viscosity: 60 mm²/s (cSt)

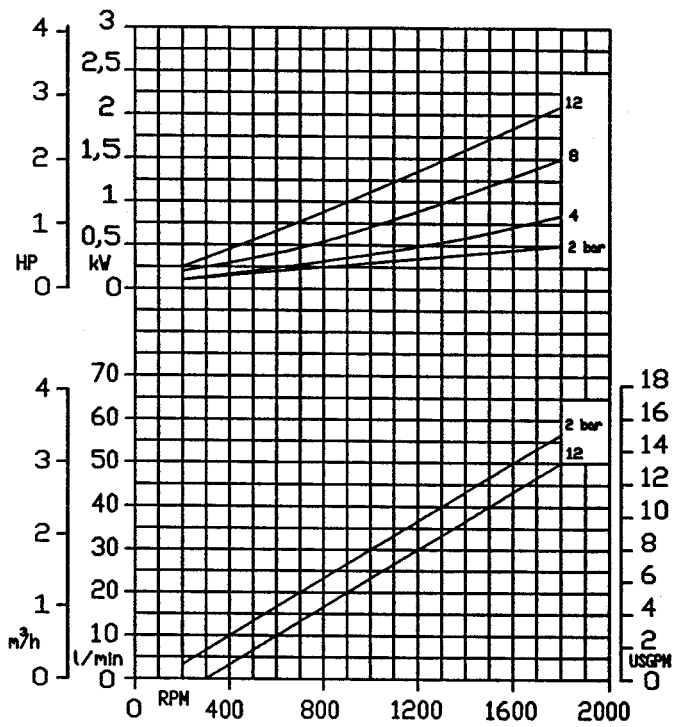

Viscosity: 200 mm²/s (cSt)

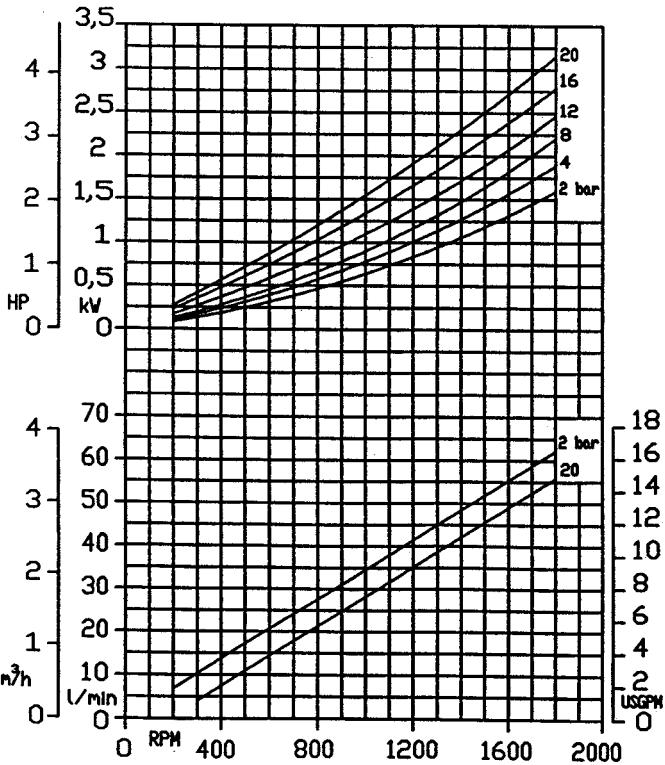

Viscosity: 600 mm²/s (cSt)

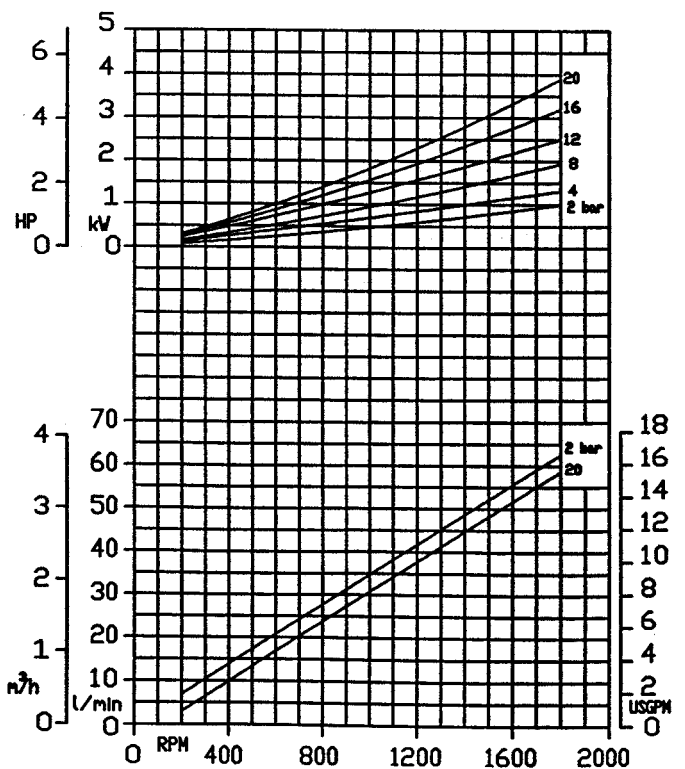

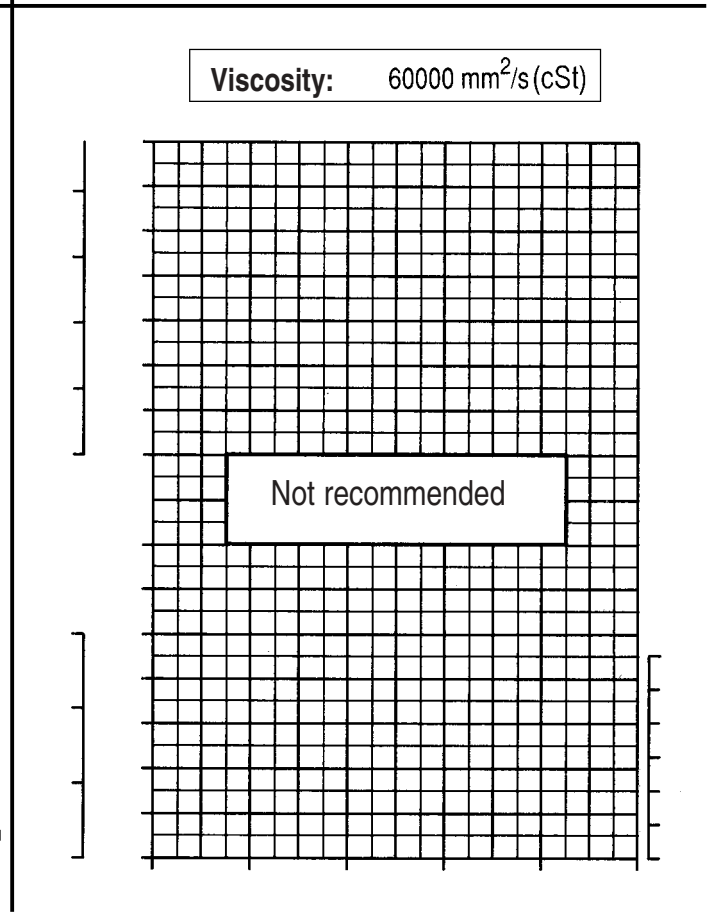
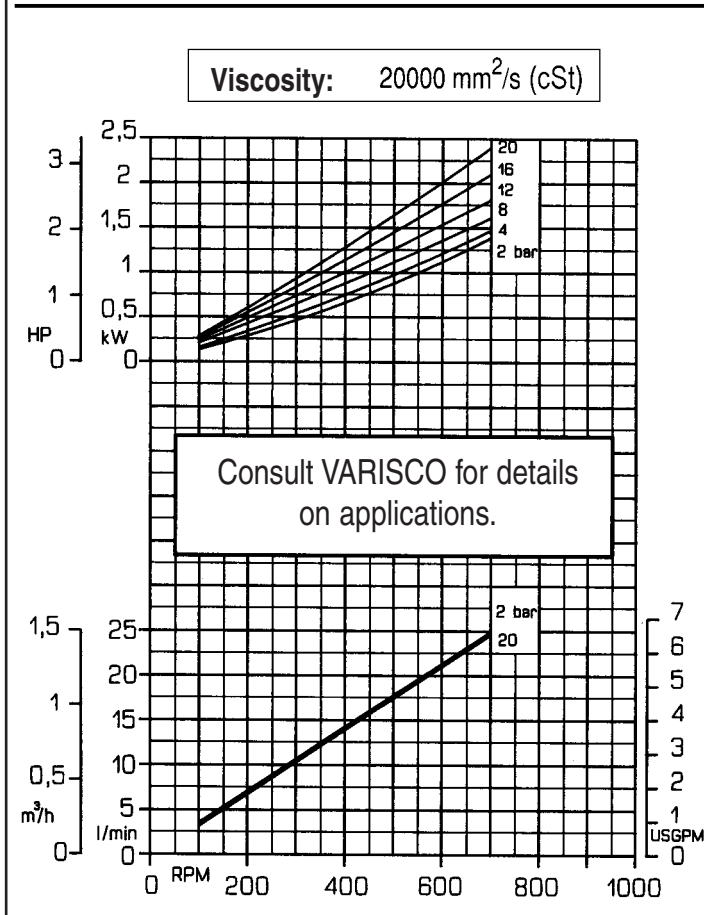
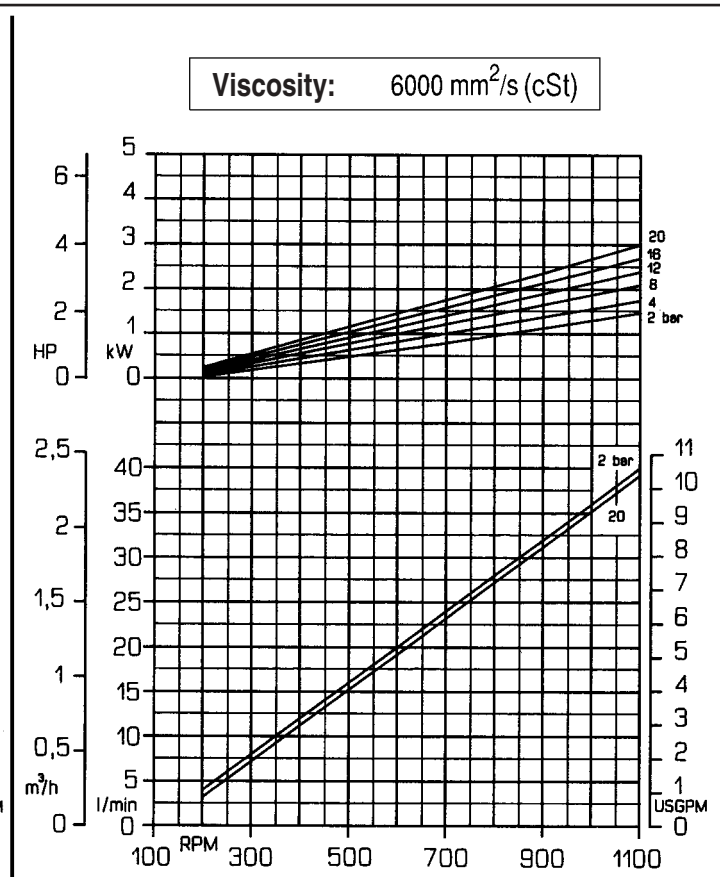
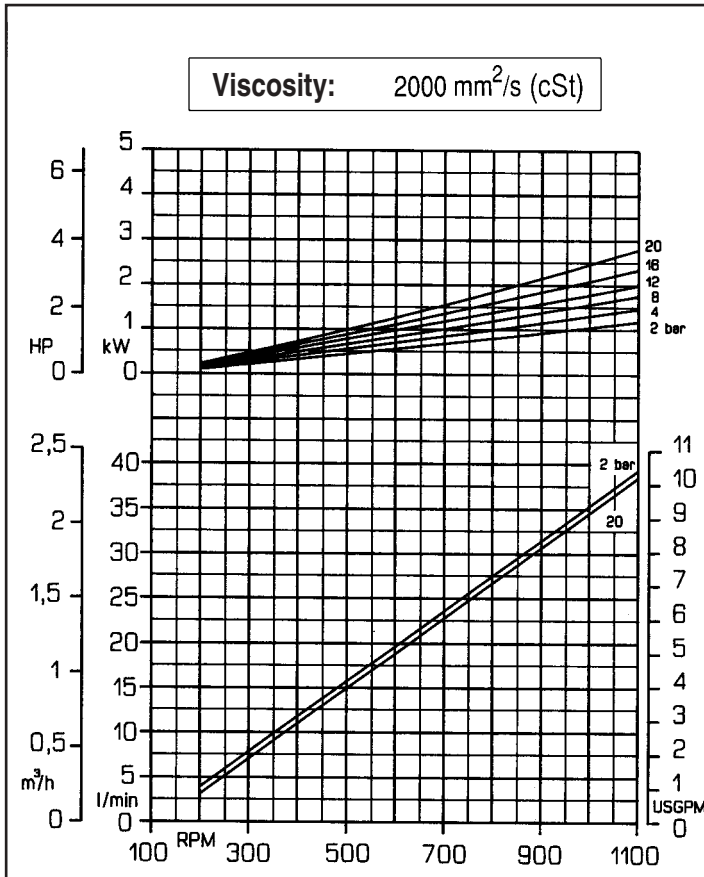

Viscosity: 20 mm²/s (cSt)

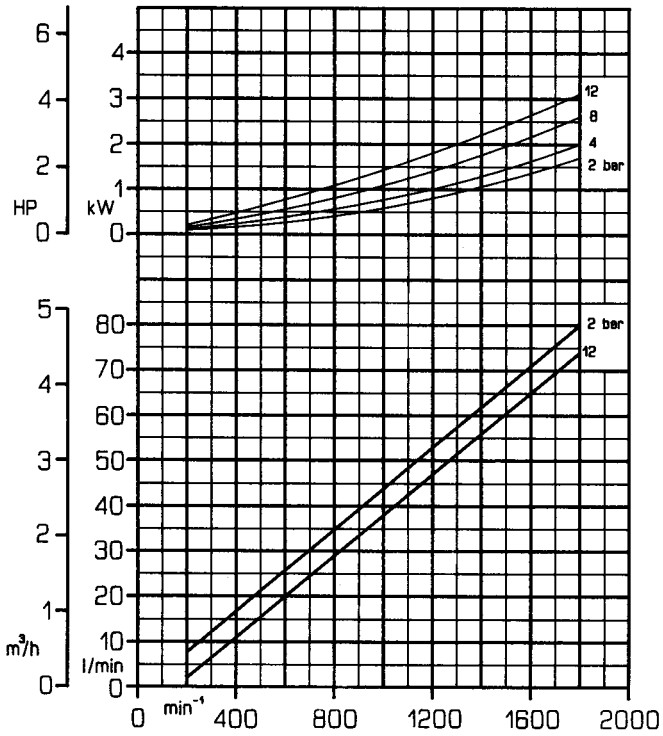

Viscosity: 60 mm²/s (cSt)

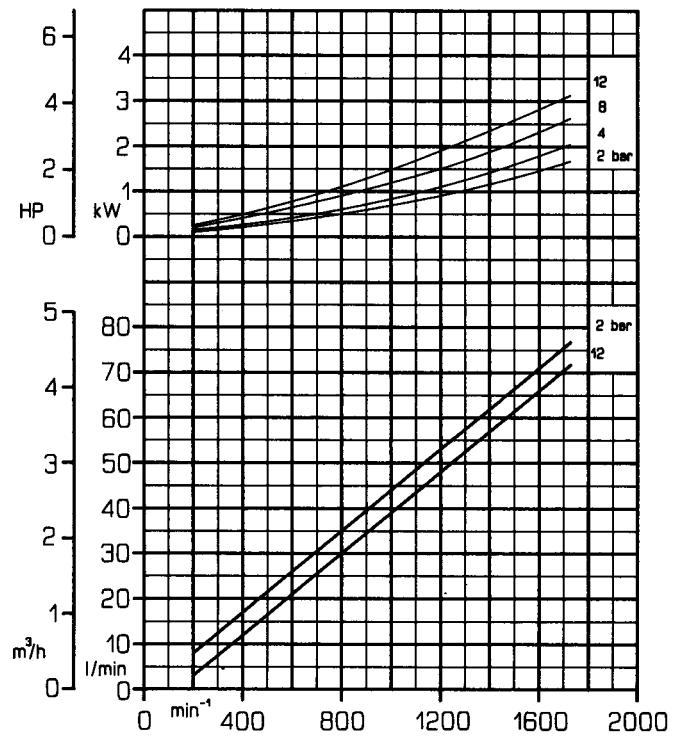

Viscosity: 200 mm²/s (cSt)

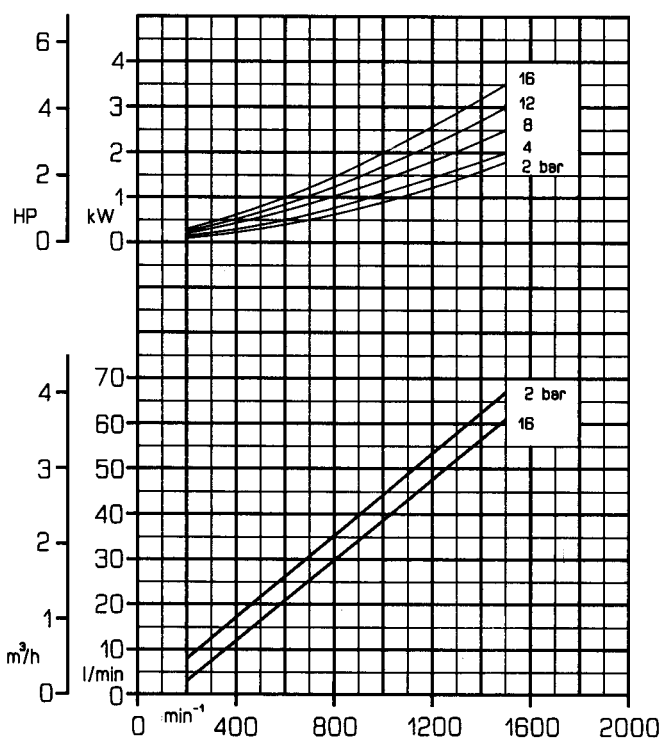

Viscosity: 600 mm²/s (cSt)

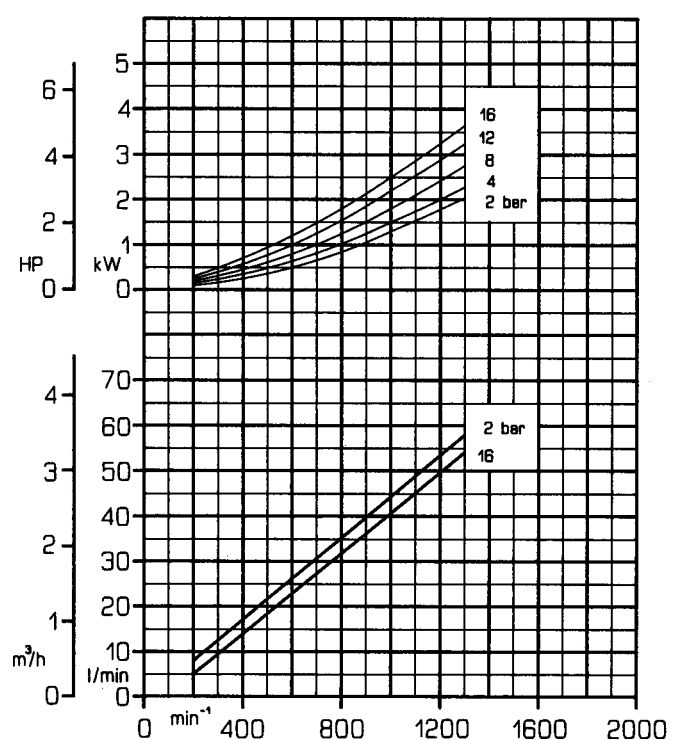

Viscosity range: from 2000 to 60.000 mm²/s
Displacement: 0,045 litres

Viscosity: 2000 mm²/s (cSt)

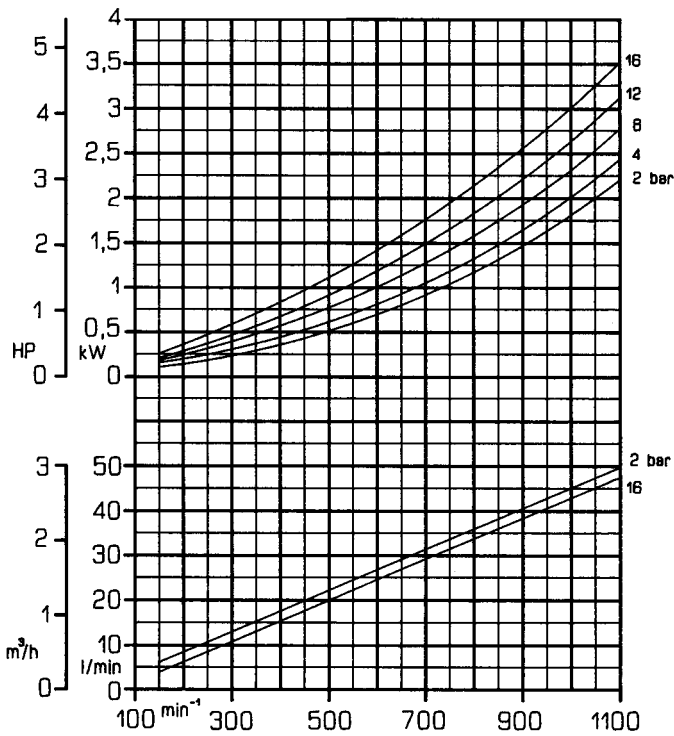

Viscosity: 6000 mm²/s (cSt)

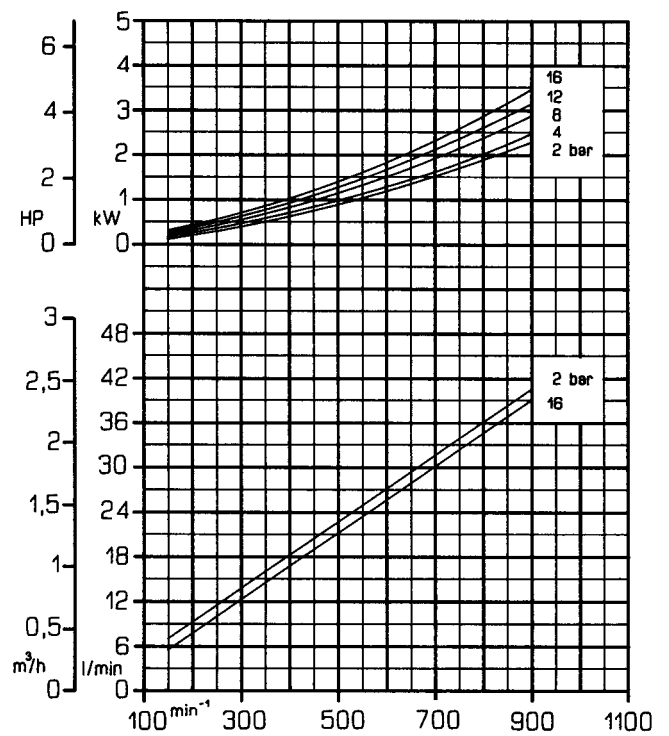

Viscosity: 20000 mm²/s (cSt)

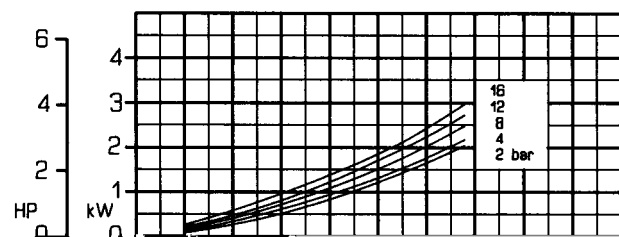

Viscosity: 60000 mm²/s (cSt)

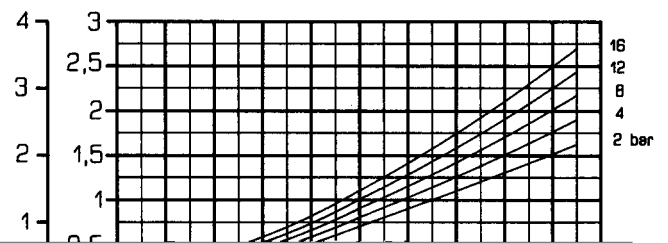

Performance curves



Viscosity range: from 20 to 600 mm²/s
 Displacement: 0,082 litres

Viscosity: 20 mm²/s (cSt)

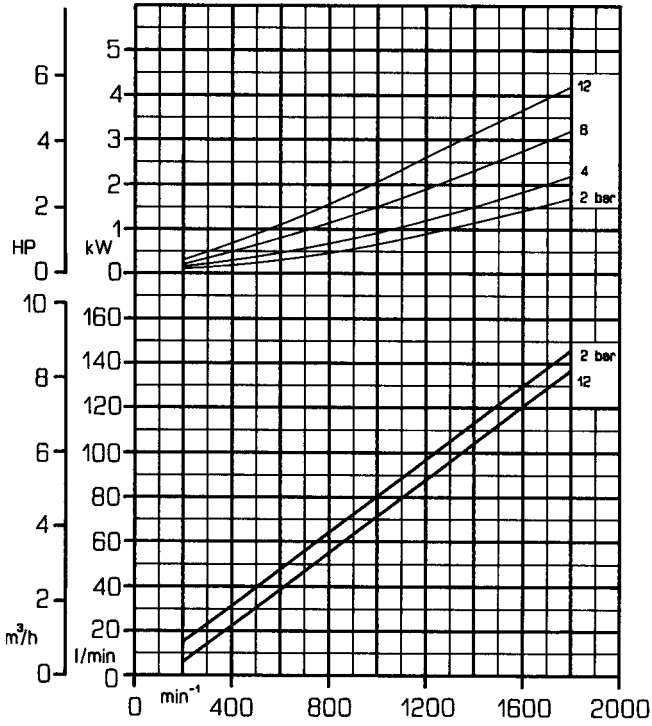

Viscosity: 60 mm²/s (cSt)

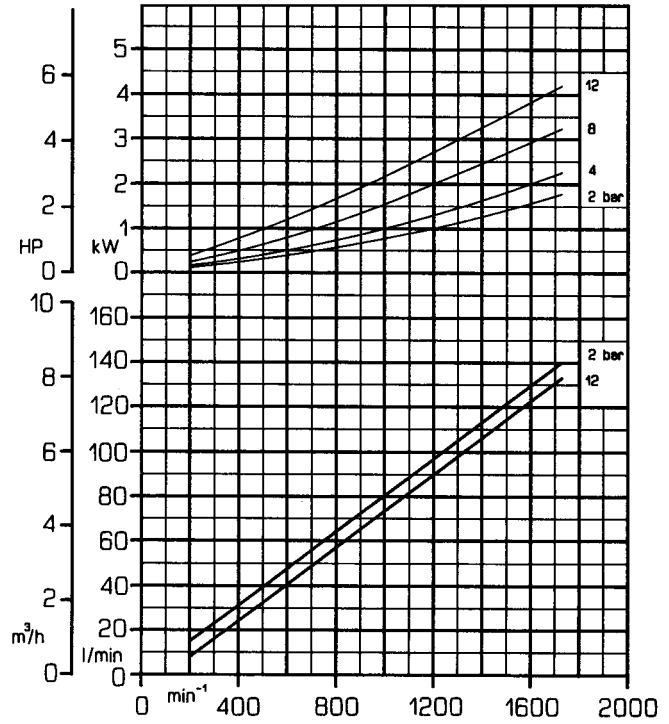

Viscosity: 200 mm²/s (cSt)

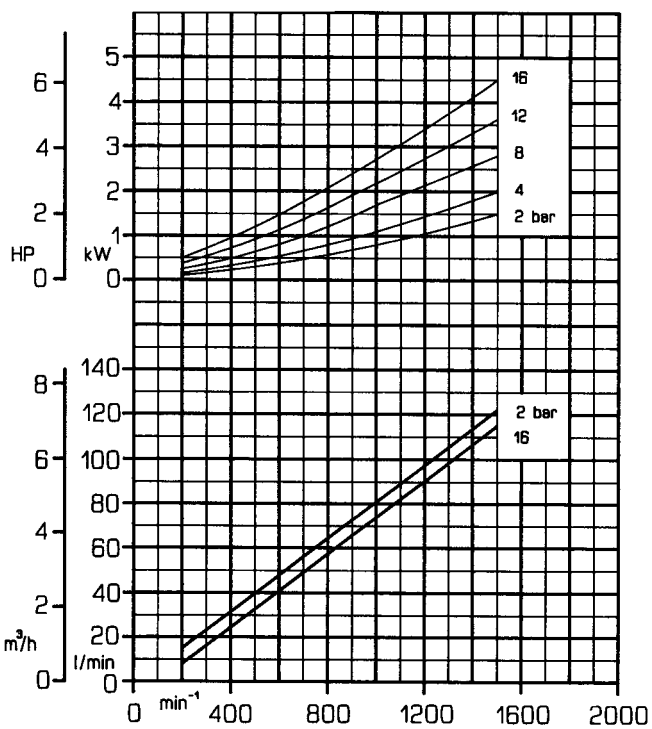

Viscosity: 600 mm²/s (cSt)

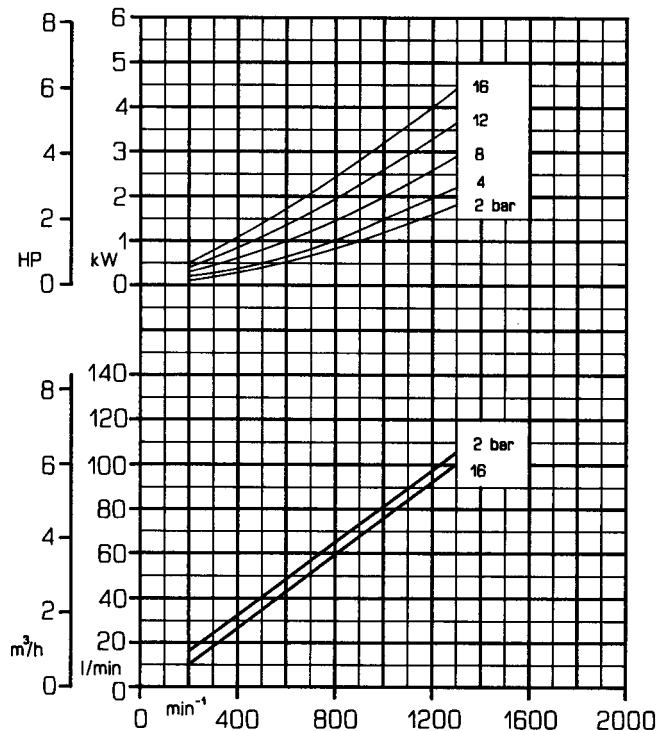

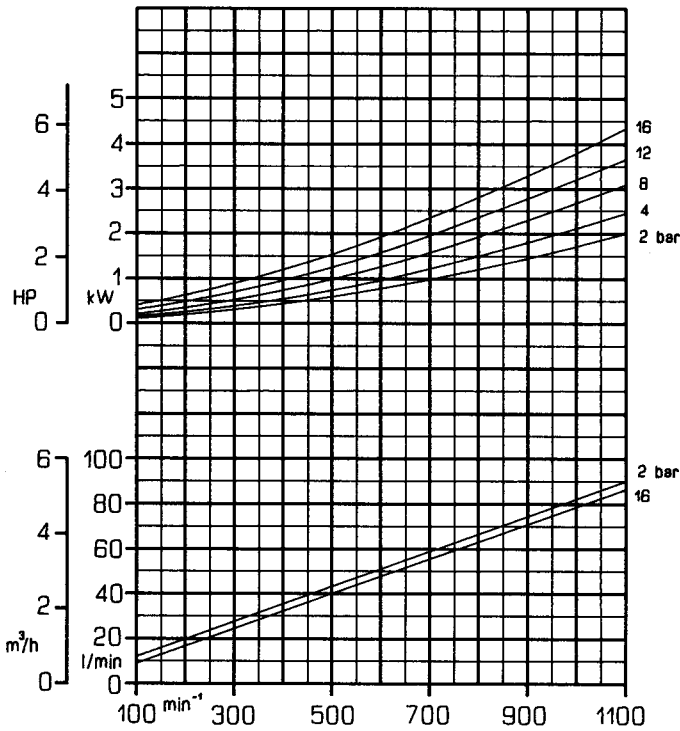
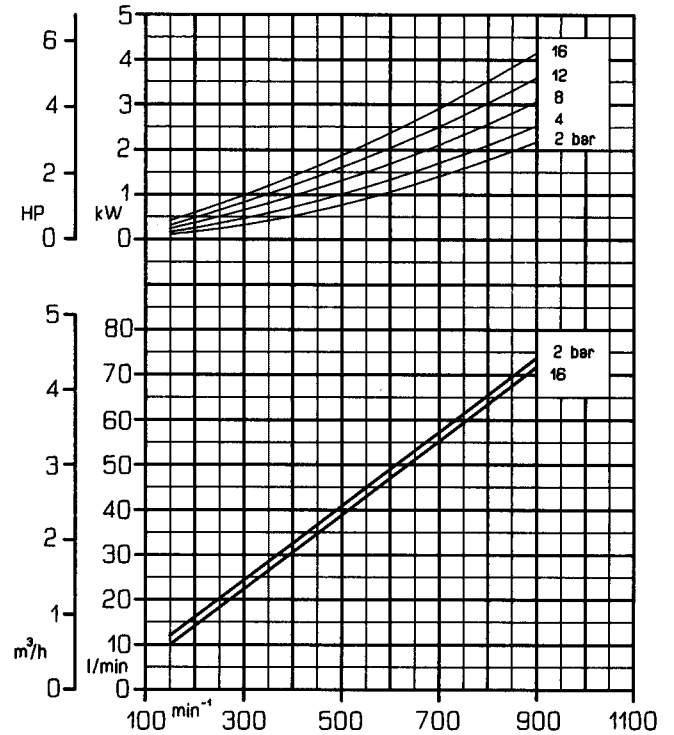
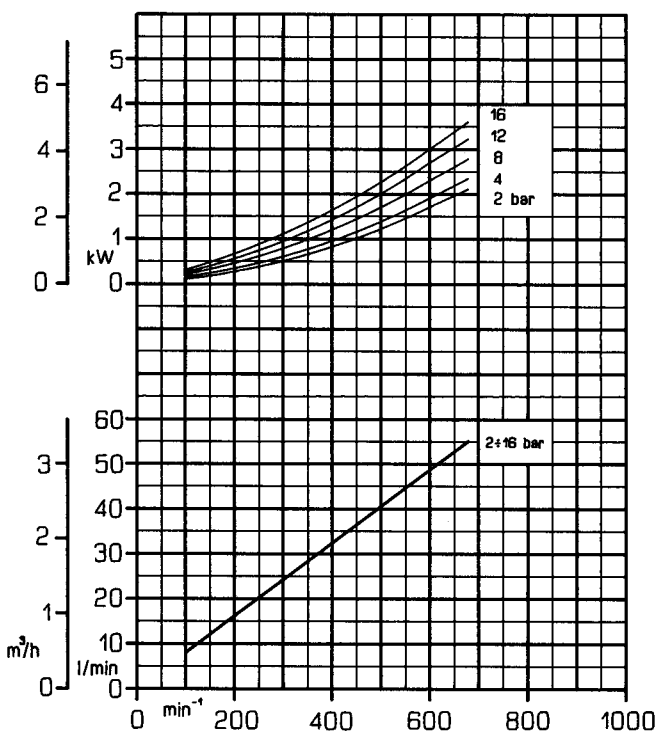
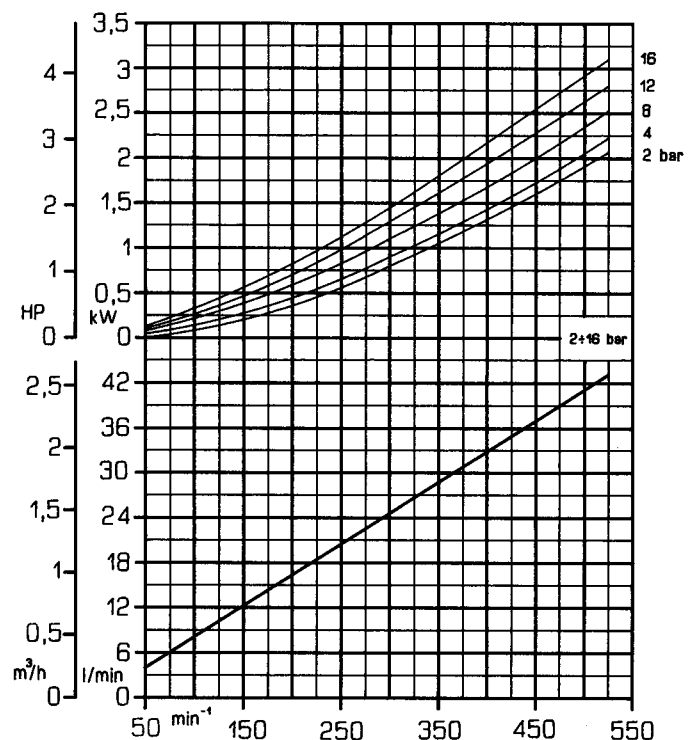
Viscosity: 2000 mm²/s (cSt)

Viscosity: 6000 mm²/s (cSt)

Viscosity: 20000 mm²/s (cSt)

Viscosity: 60000 mm²/s (cSt)

Performance curves

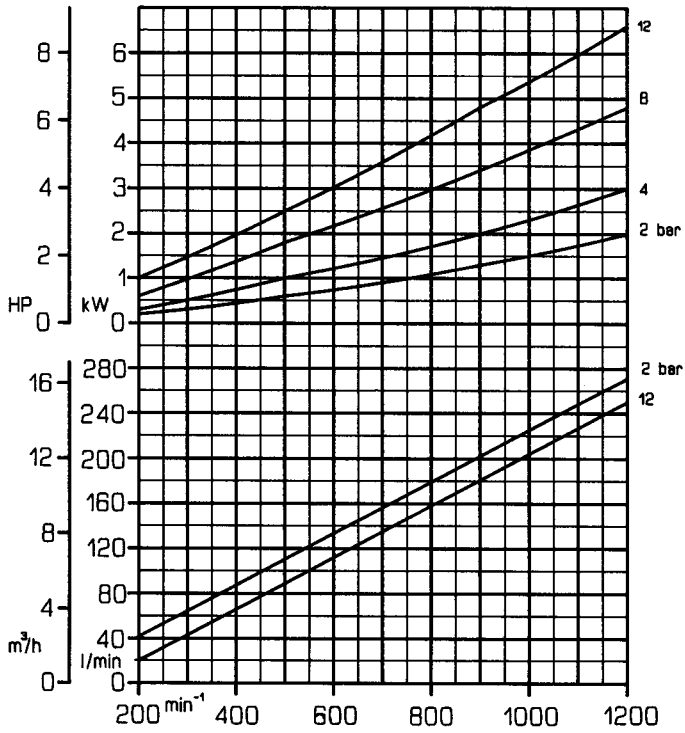

Viscosity range: from 20 to 600 mm²/s
 Displacement: 0,230 litres

Viscosity: 20 mm²/s (cSt)



Viscosity: 60 mm²/s (cSt)

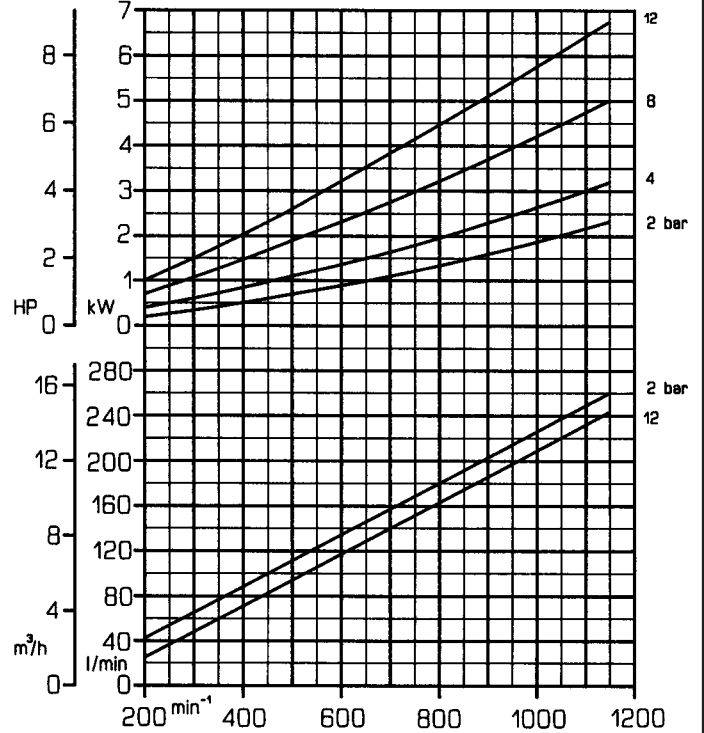

Viscosity: 200 mm²/s (cSt)

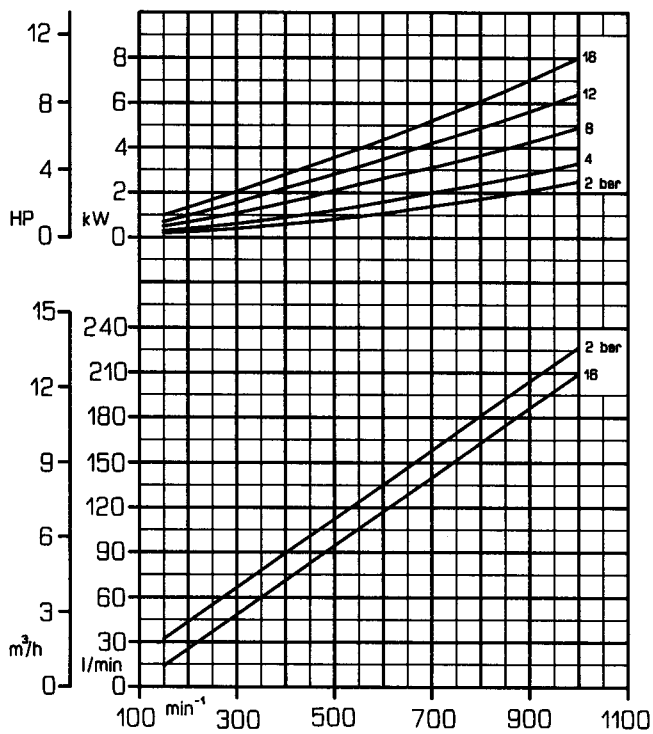

Viscosity: 600 mm²/s (cSt)

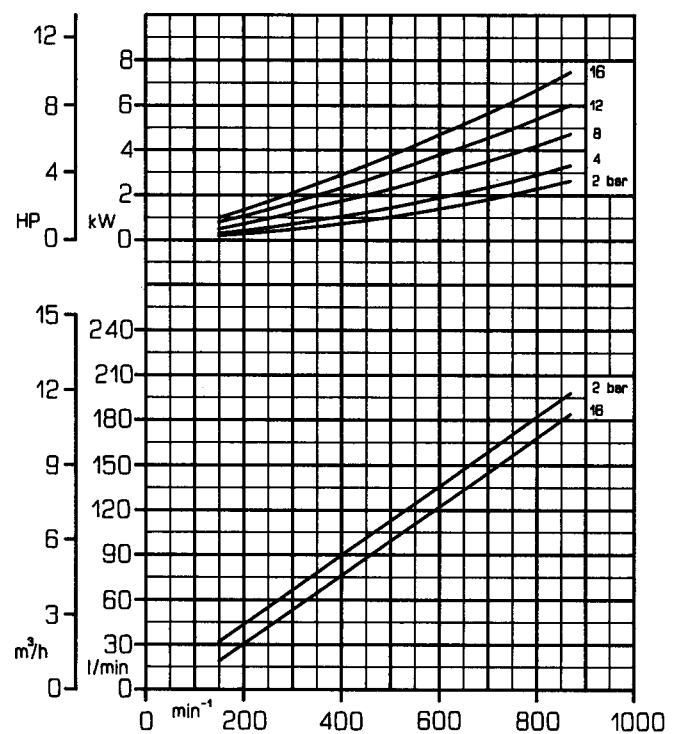

Viscosity: 2000 mm²/s (cSt)

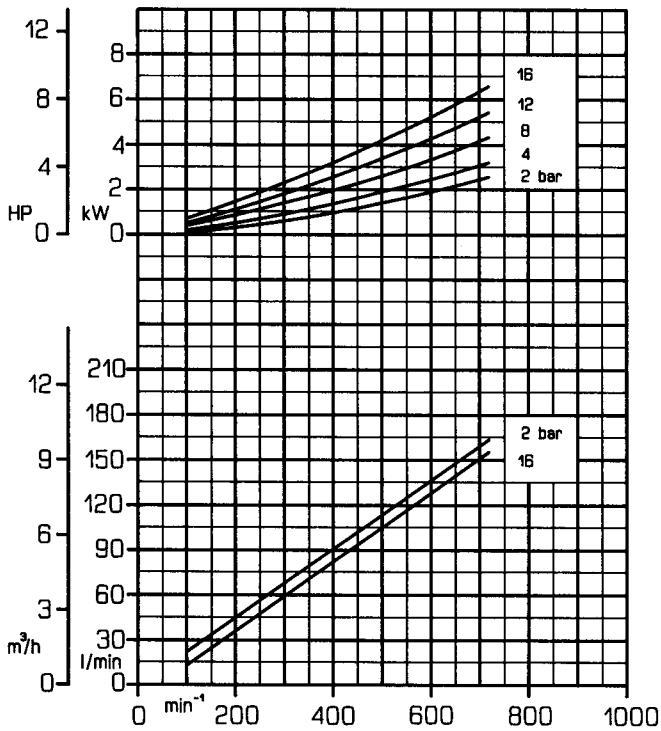

Viscosity: 6000 mm²/s (cSt)

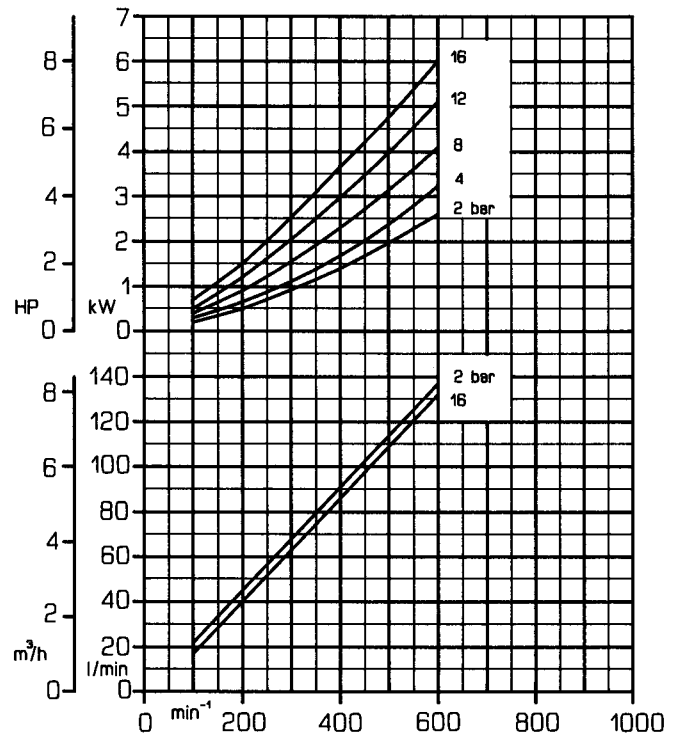

Viscosity: 20000 mm²/s (cSt)

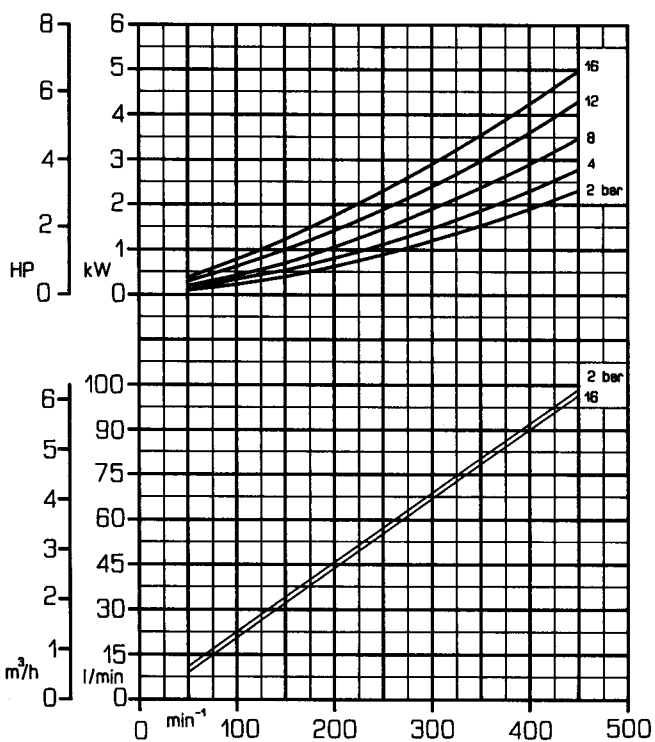

Viscosity: 60000 mm²/s (cSt)

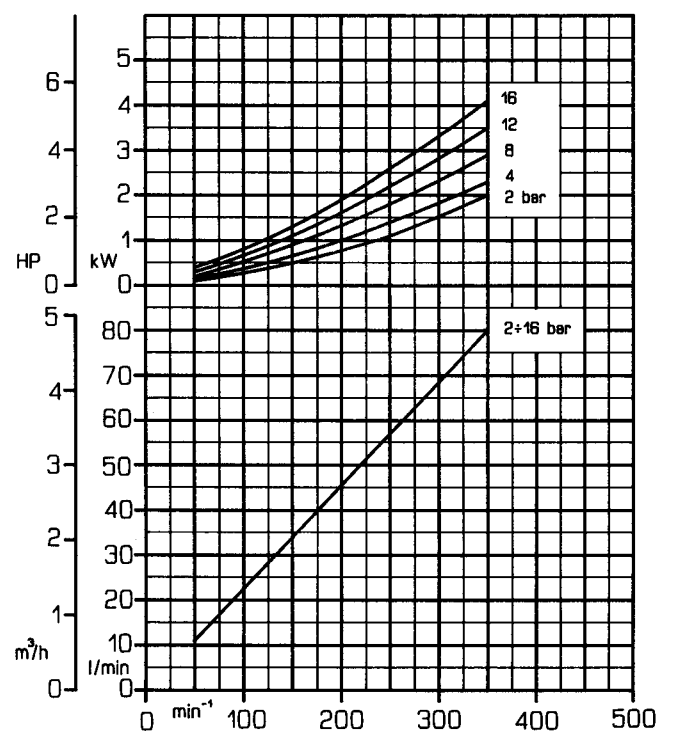

Performance curves



Viscosity range: from 20 to 600 mm²/s
 Displacement: 0,500 litres

Viscosity: 20 mm²/s (cSt)

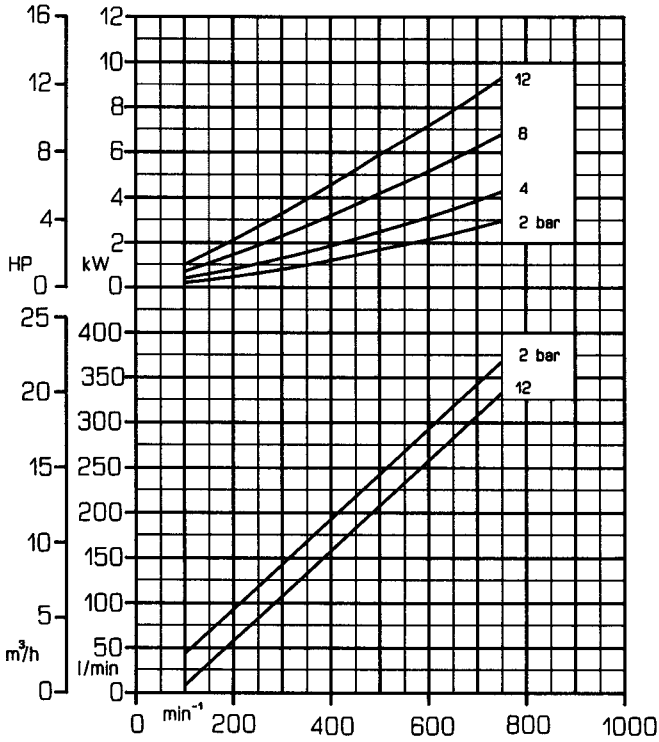

Viscosity: 60 mm²/s (cSt)

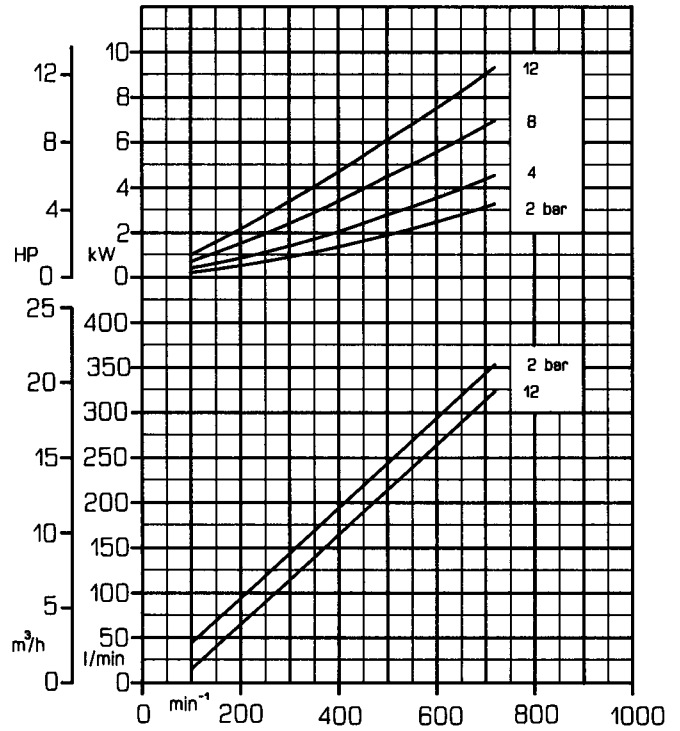

Viscosity: 200 mm²/s (cSt)

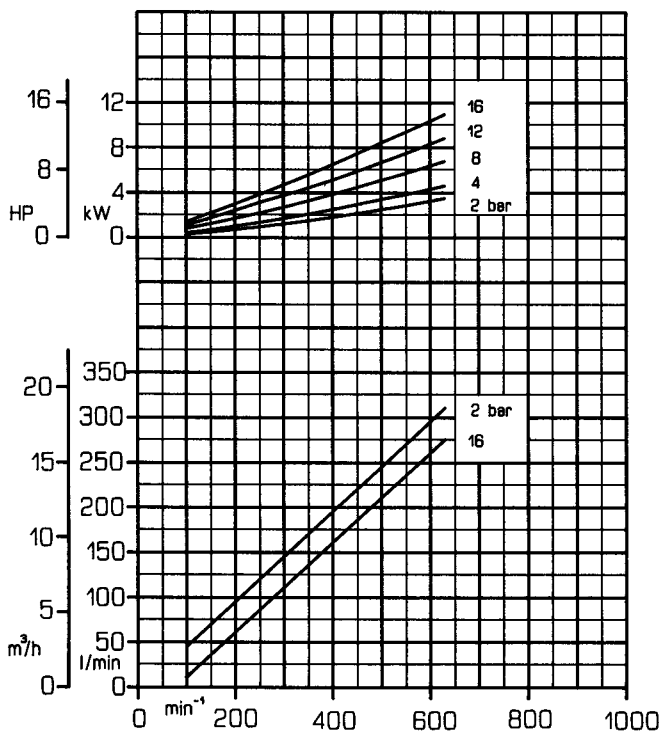

Viscosity: 600 mm²/s (cSt)

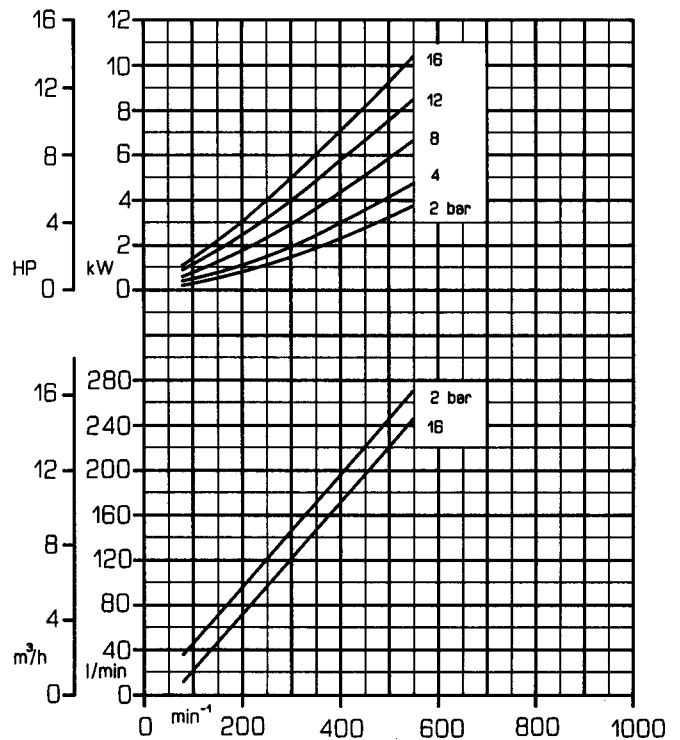

Viscosity: 2000 mm²/s (cSt)

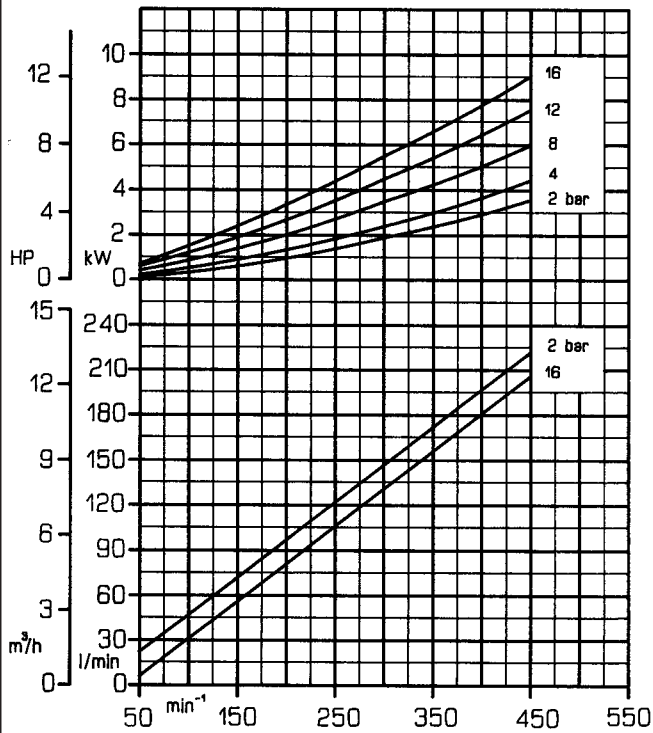

Viscosity: 6000 mm²/s (cSt)

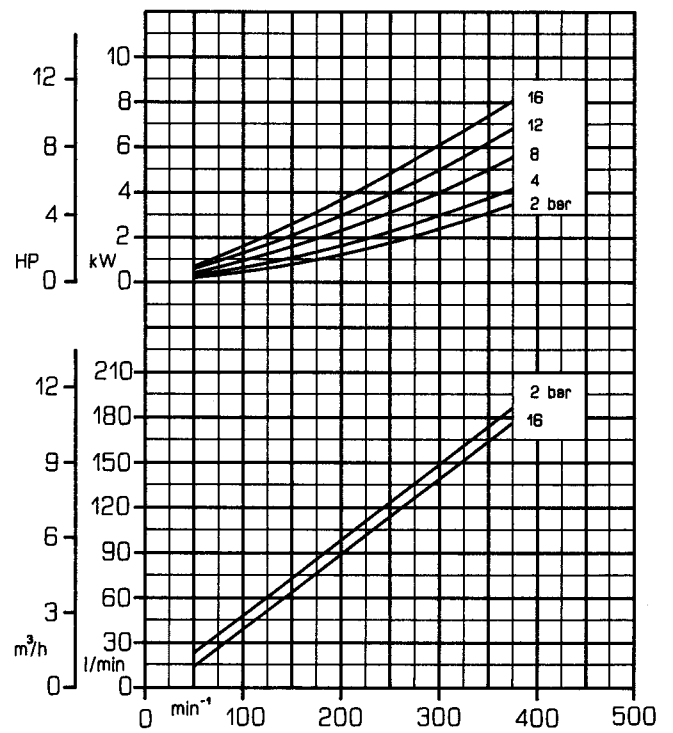

Viscosity: 20000 mm²/s (cSt)

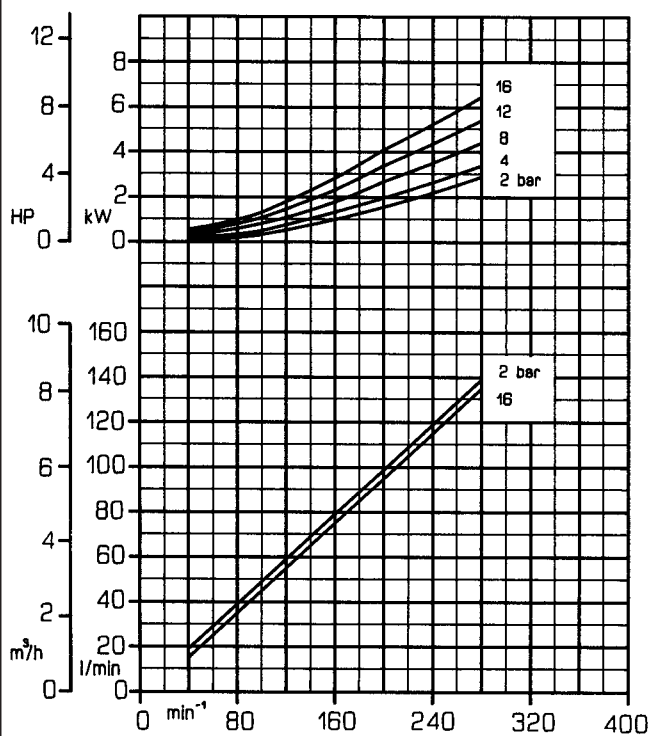

Viscosity: 60000 mm²/s (cSt)

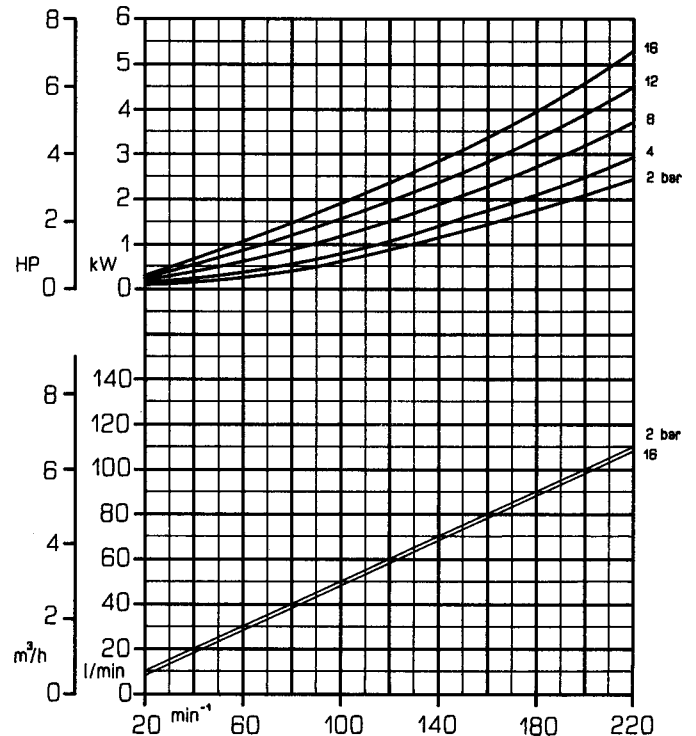

Performance curves



Viscosity range: from 20 to 600 mm²/s
 Displacement: 0,800 litres

Viscosity: 20 mm²/s (cSt)

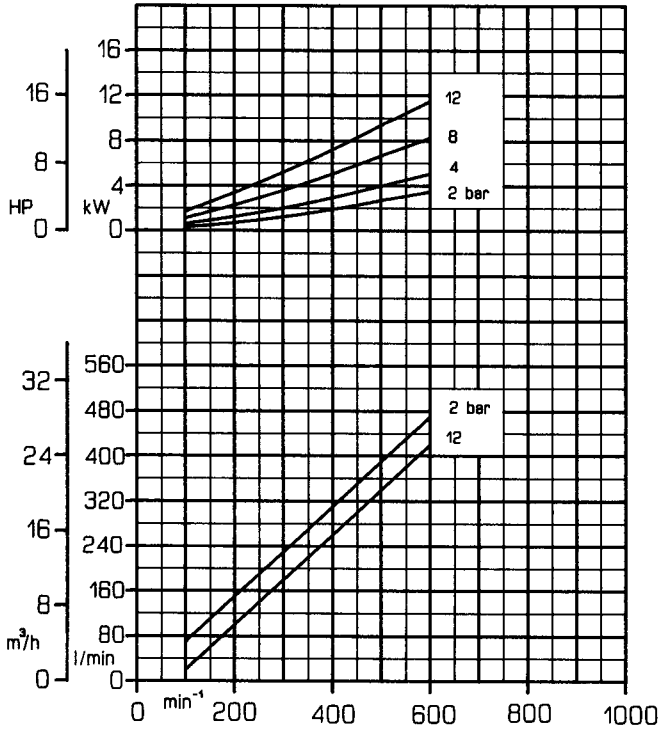

Viscosity: 60 mm²/s (cSt)

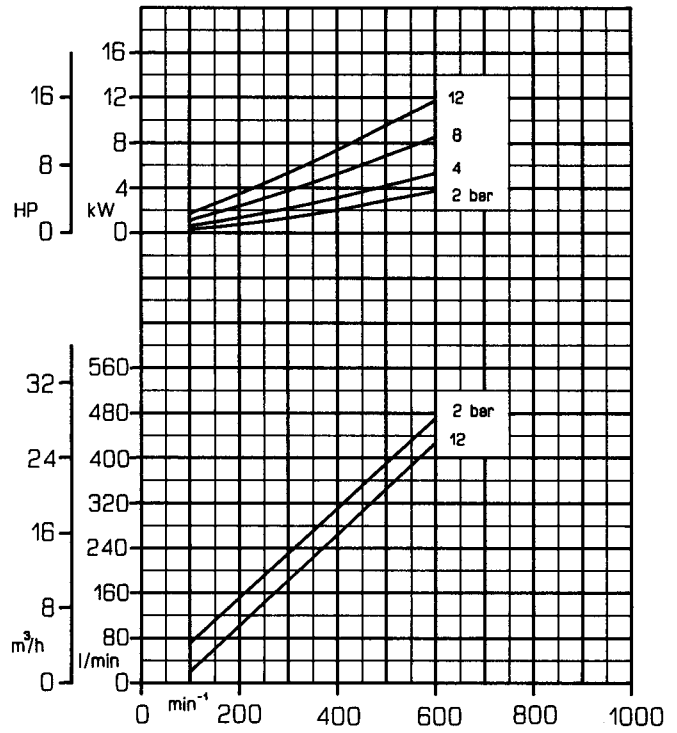

Viscosity: 200 mm²/s (cSt)

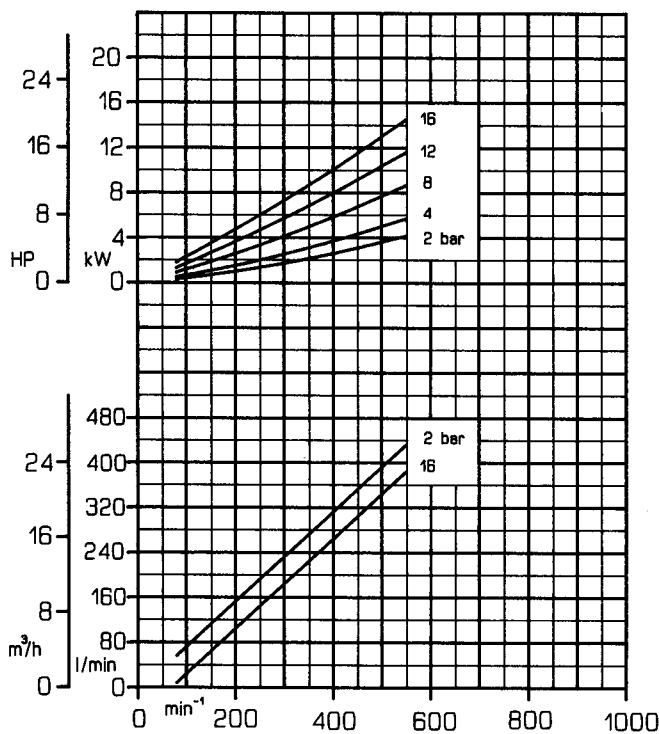

Viscosity: 600 mm²/s (cSt)

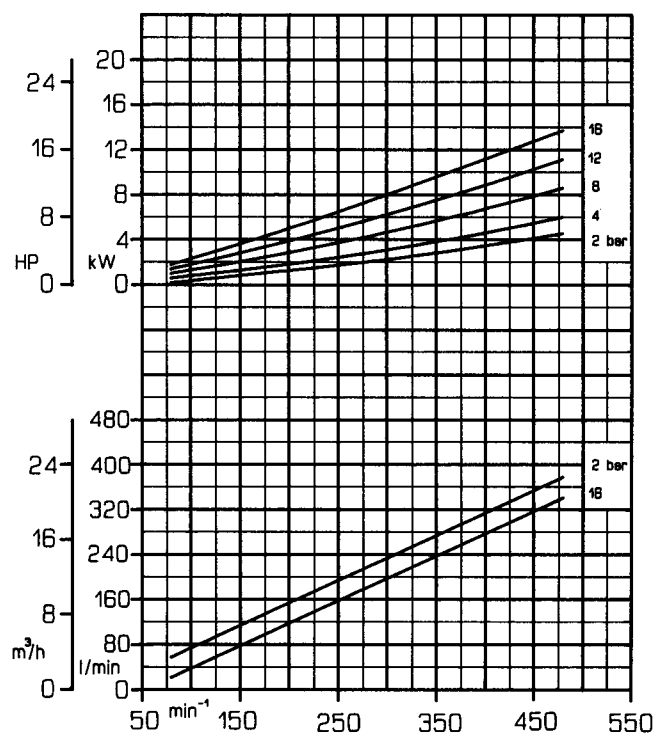

Viscosity: 2000 mm²/s (cSt)

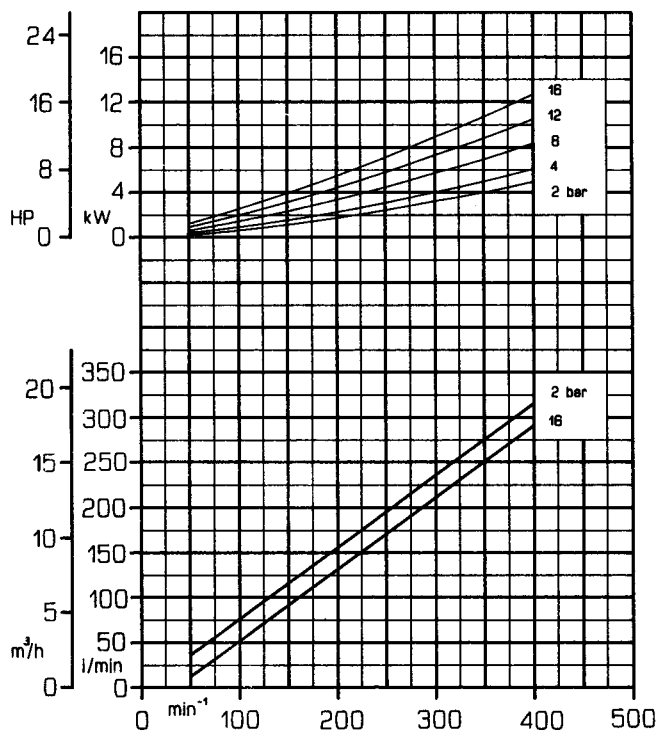

Viscosity: 6000 mm²/s (cSt)

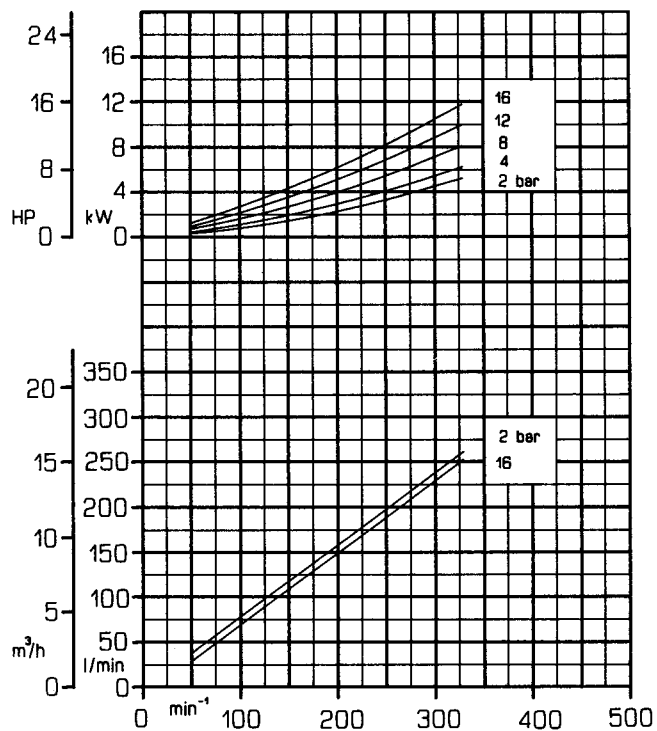

Viscosity: 20000 mm²/s (cSt)

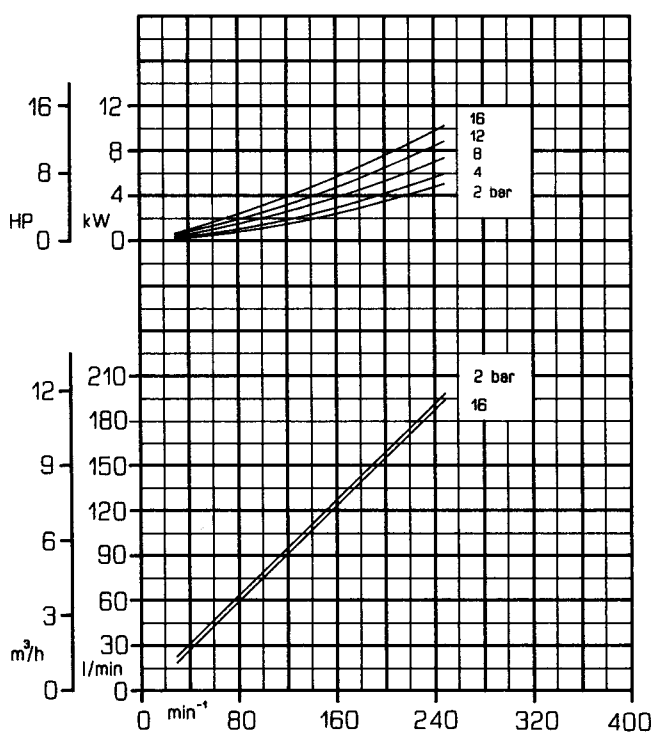

Viscosity: 60000 mm²/s (cSt)

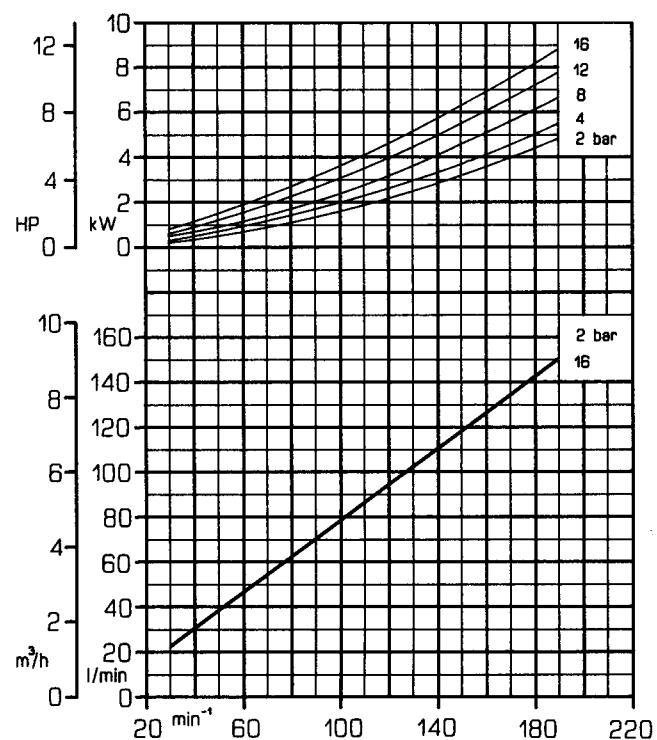

Performance curves



Viscosity range: from 20 to 600 mm²/s
 Displacement: 1,200 litres

Viscosity: 20 mm²/s (cSt)

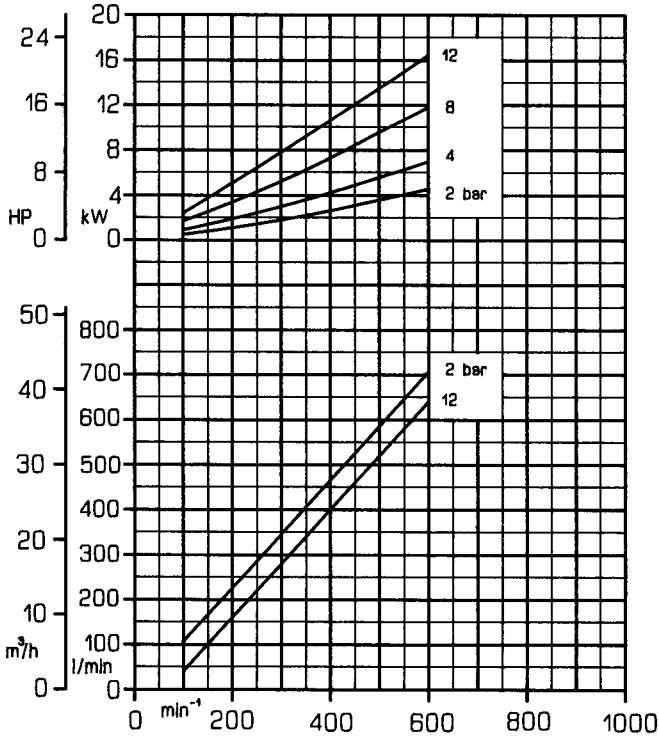

Viscosity: 60 mm²/s (cSt)

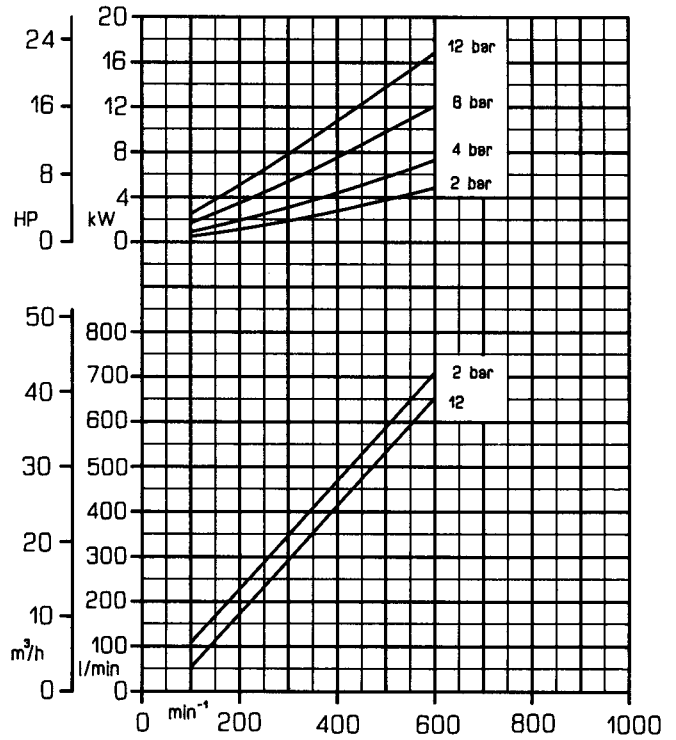

Viscosity: 200 mm²/s (cSt)

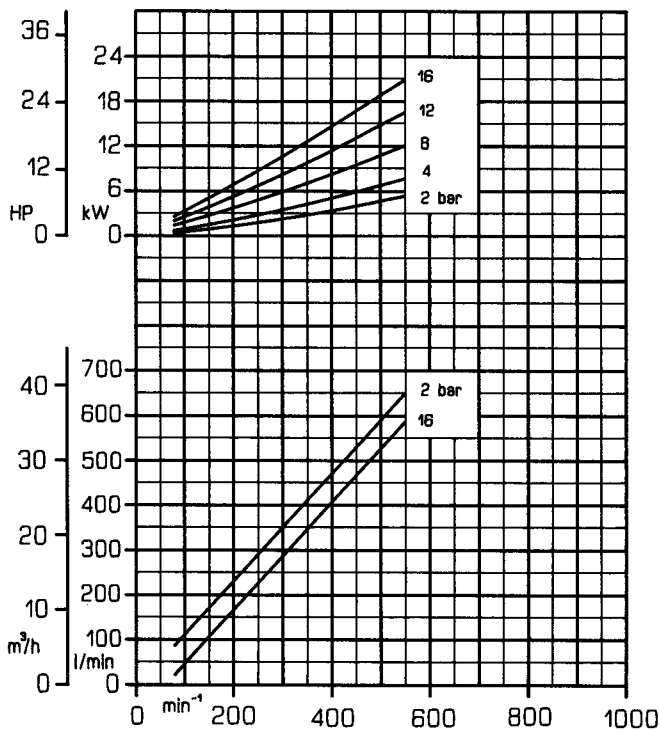

Viscosity: 600 mm²/s (cSt)

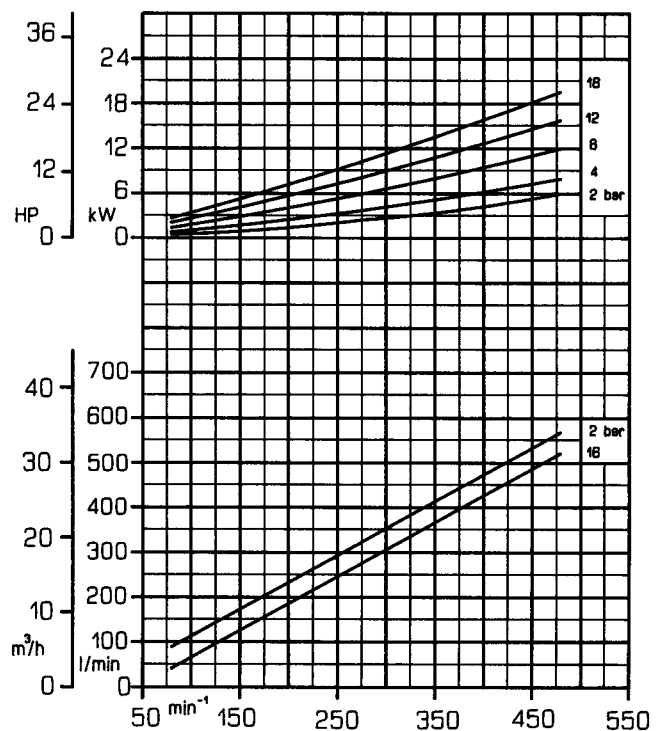

Viscosity: 2000 mm²/s (cSt)

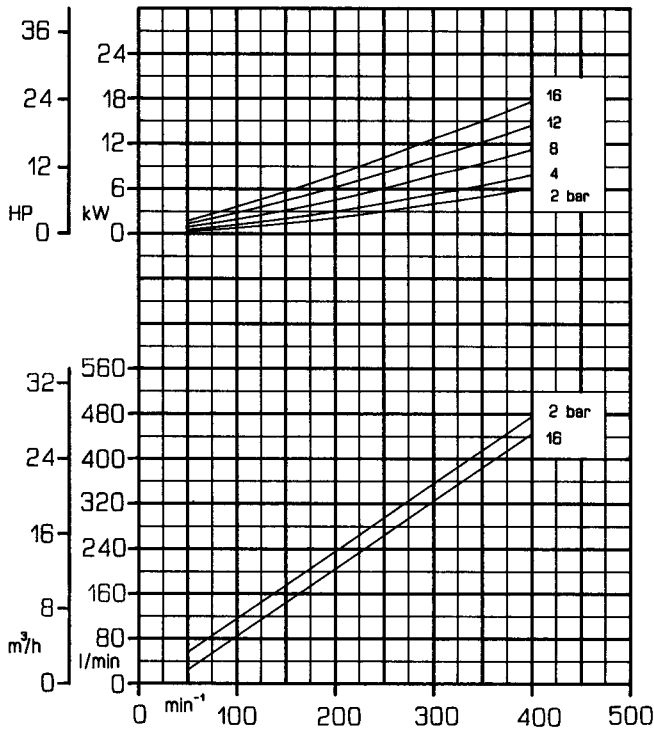

Viscosity: 6000 mm²/s (cSt)

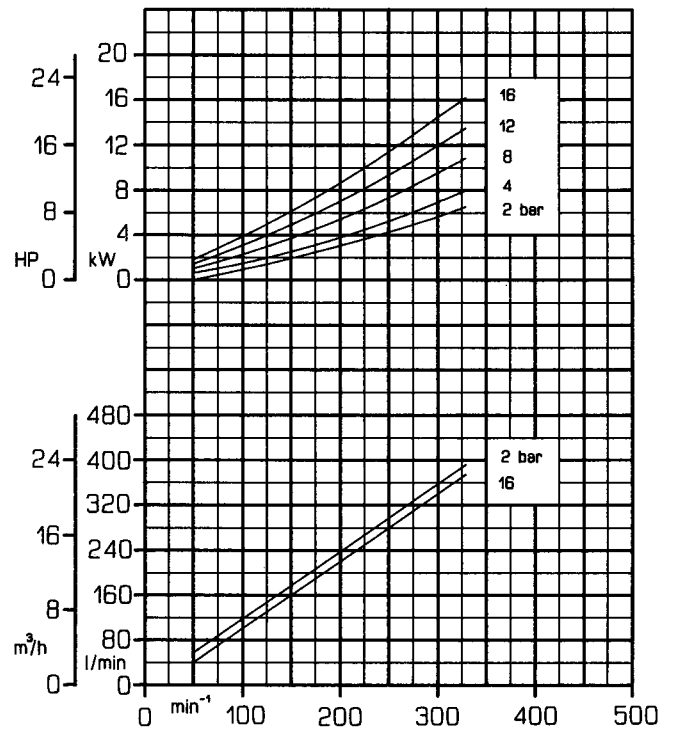

Viscosity: 20000 mm²/s (cSt)

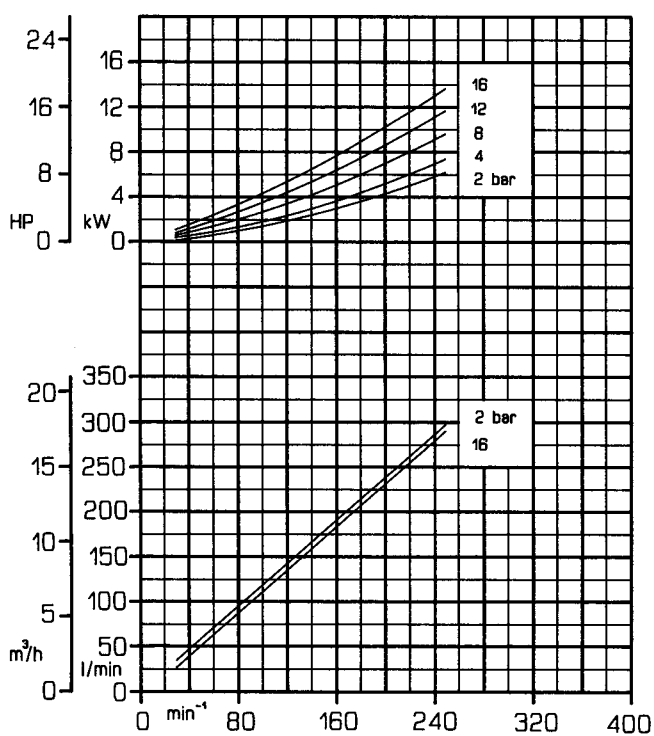

Viscosity: 60000 mm²/s (cSt)

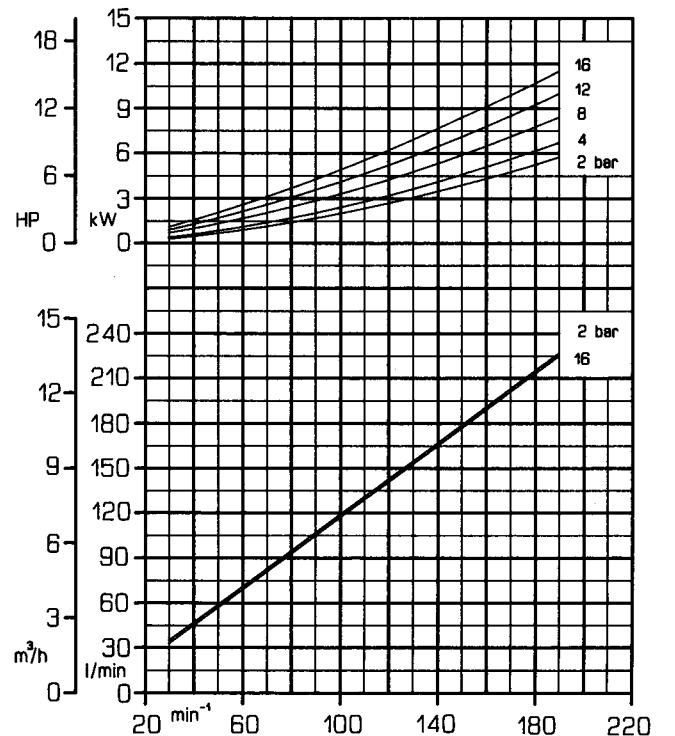

Performance curves



Viscosity range: from 20 to 600 mm²/s
 Displacement: 1,600 litres

Viscosity: 20 mm²/s (cSt)

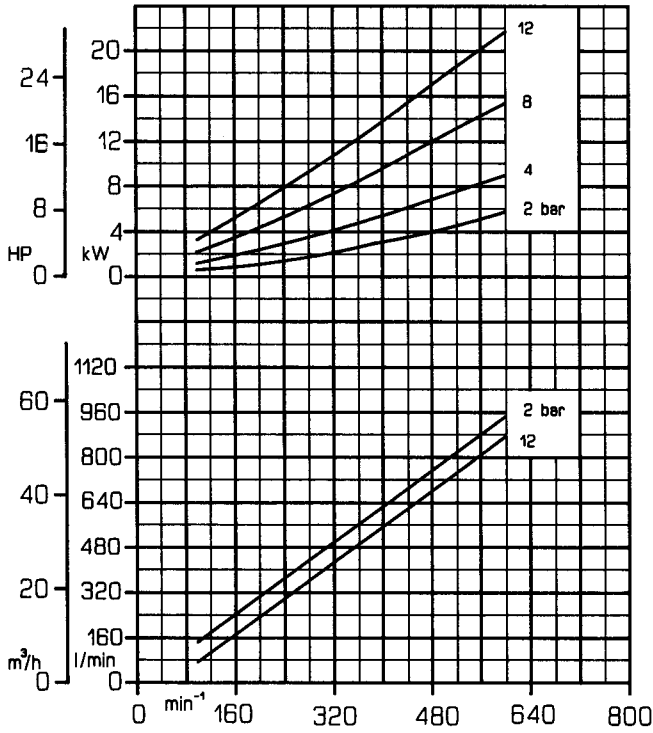

Viscosity: 60 mm²/s (cSt)

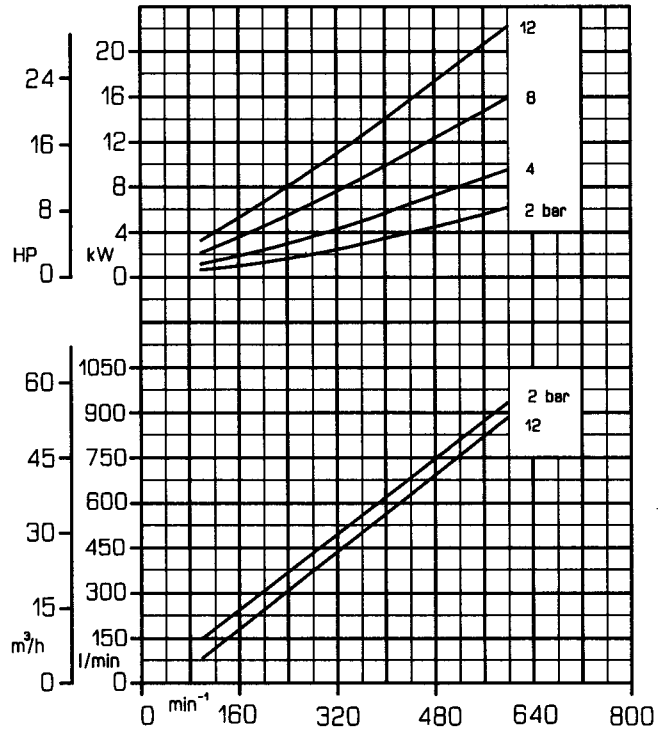

Viscosity: 200 mm²/s (cSt)

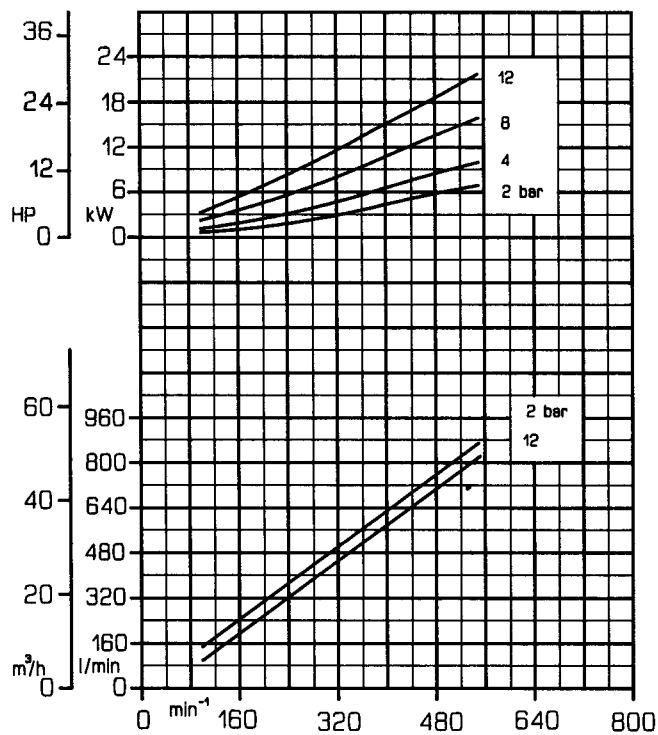

Viscosity: 600 mm²/s (cSt)

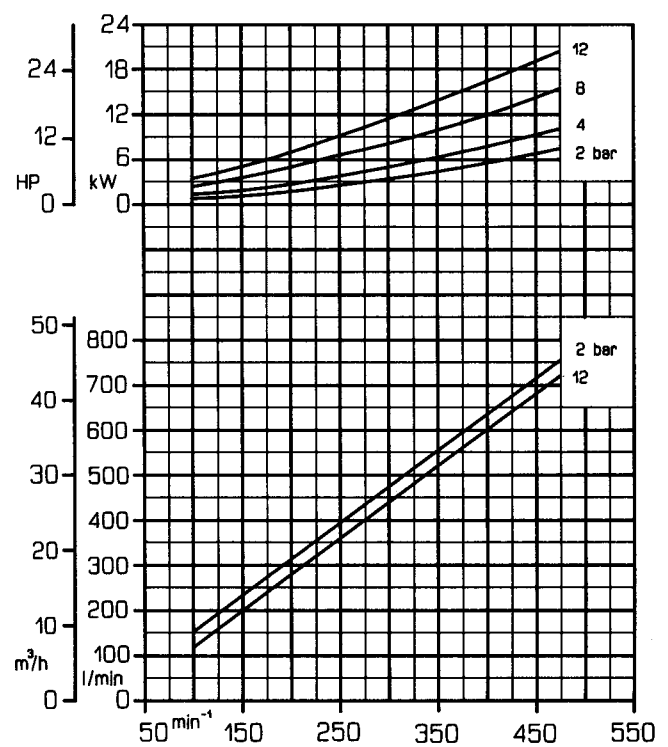

Viscosity: 2000 mm²/s (cSt)

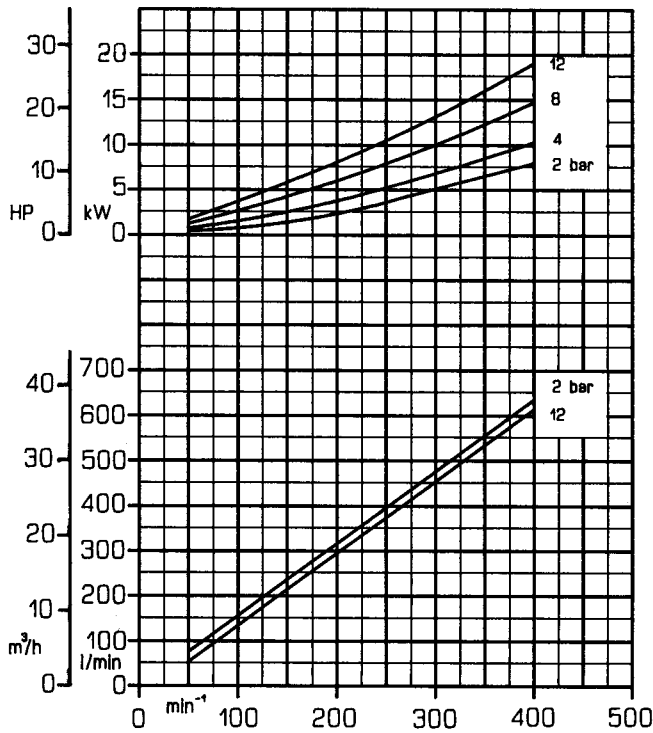

Viscosity: 6000 mm²/s (cSt)

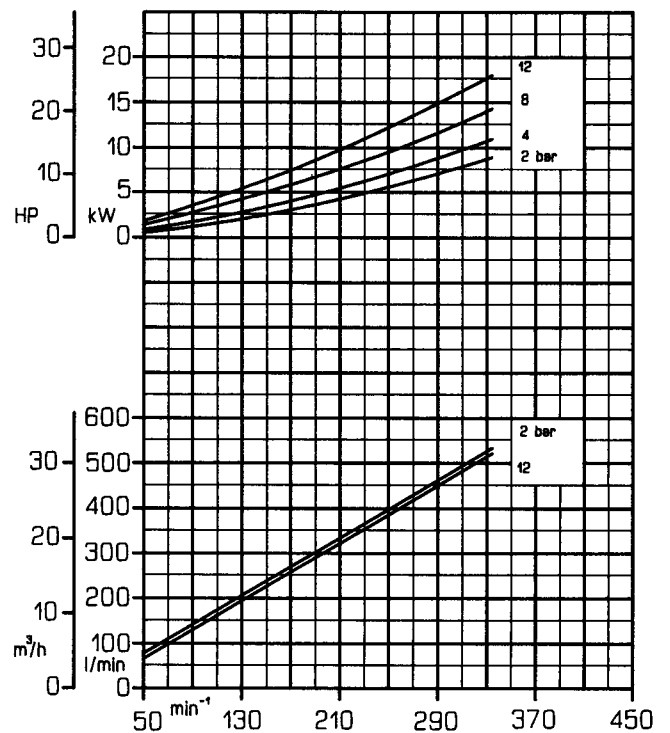

Viscosity: 20000 mm²/s (cSt)

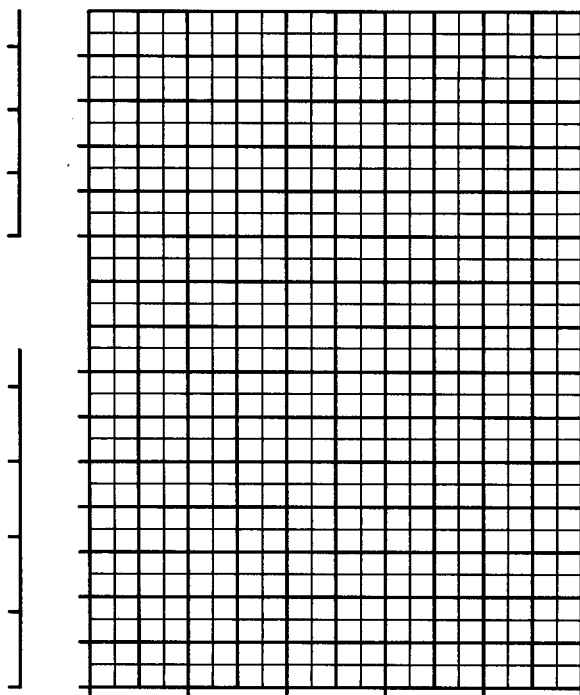

Viscosity: 60000 mm²/s (cSt)

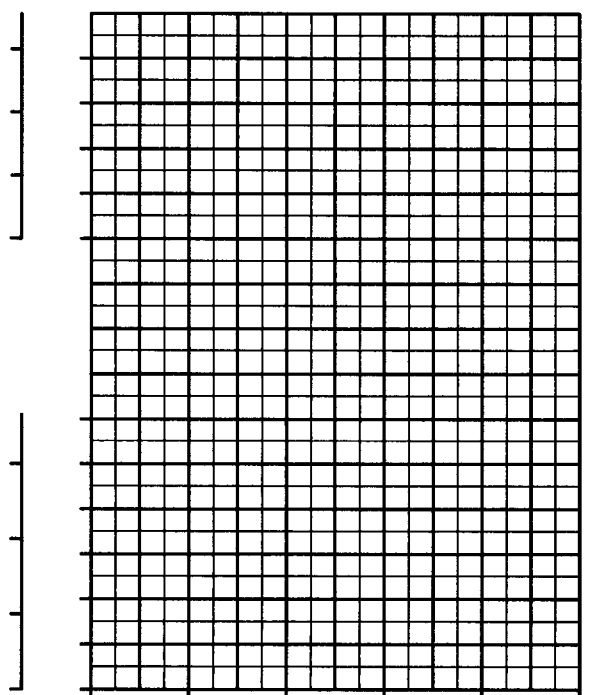

Performance curves



Viscosity range: from 20 to 600 mm²/s
 Displacement: 2,200 litres

Viscosity: 20 mm²/s (cSt)

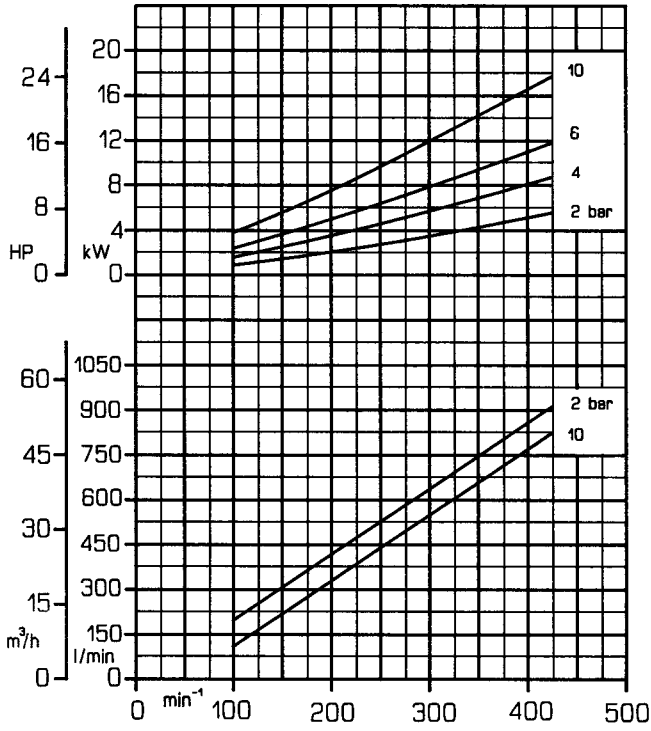

Viscosity: 60 mm²/s (cSt)

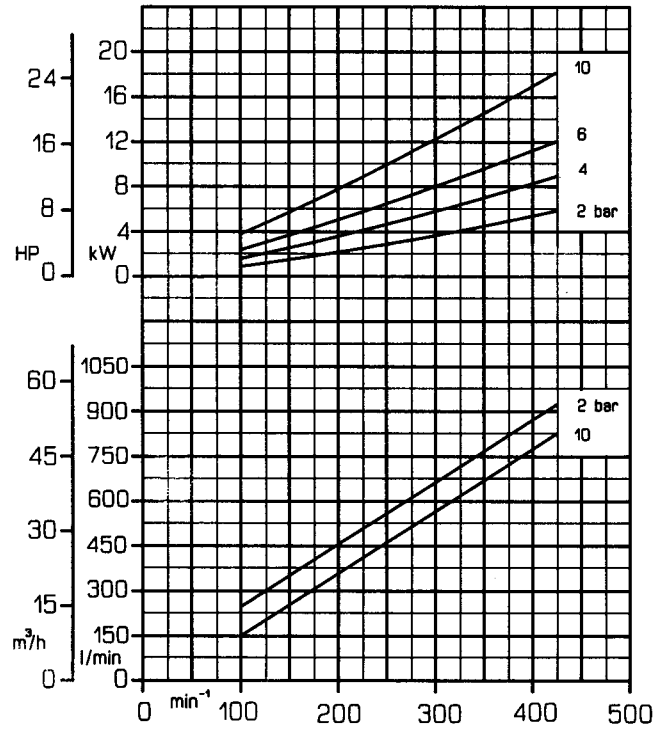

Viscosity: 200 mm²/s (cSt)

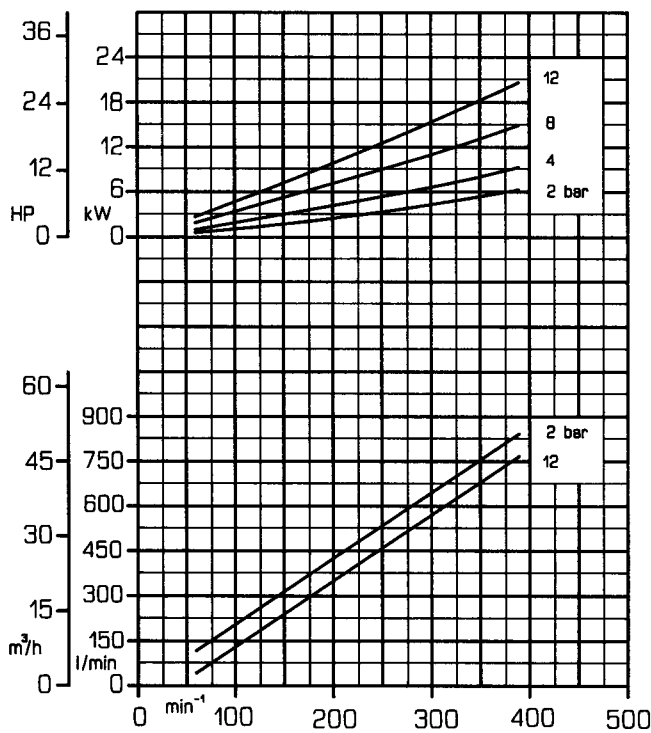

Viscosity: 600 mm²/s (cSt)

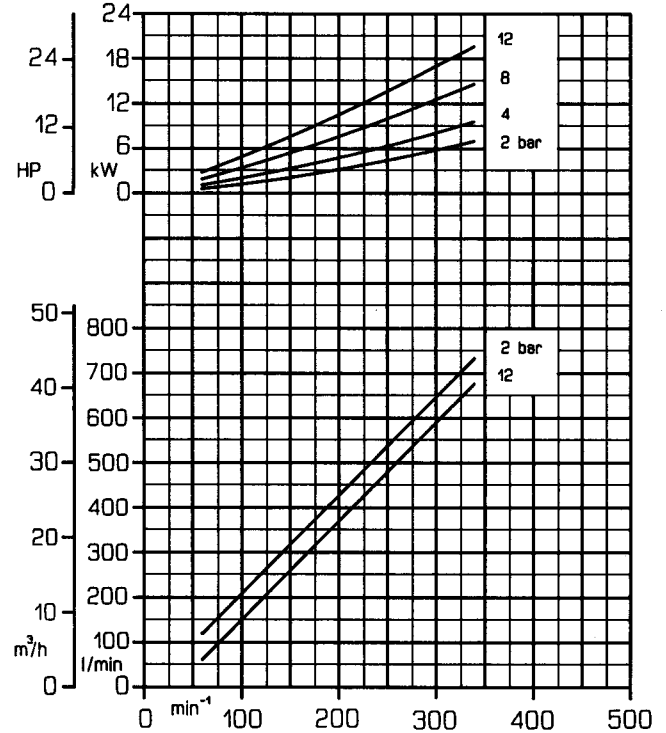

Viscosity: 2000 mm²/s (cSt)

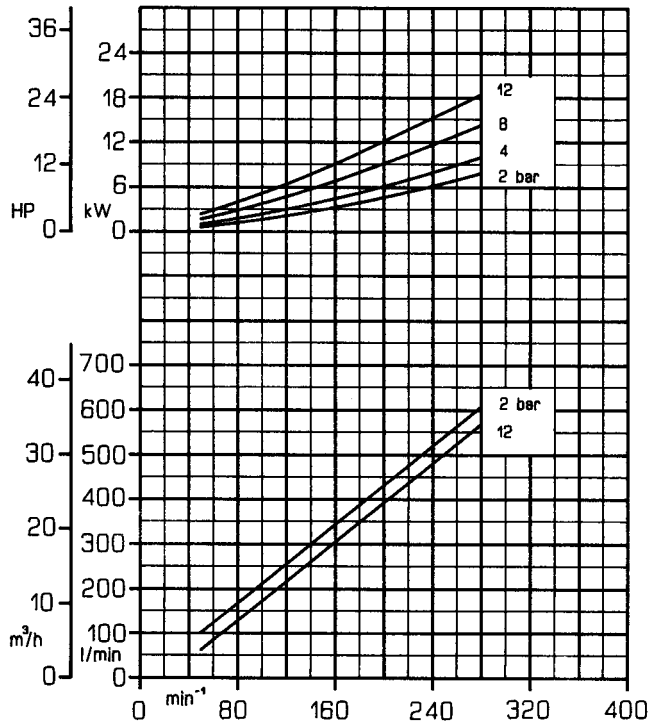

Viscosity: 6000 mm²/s (cSt)

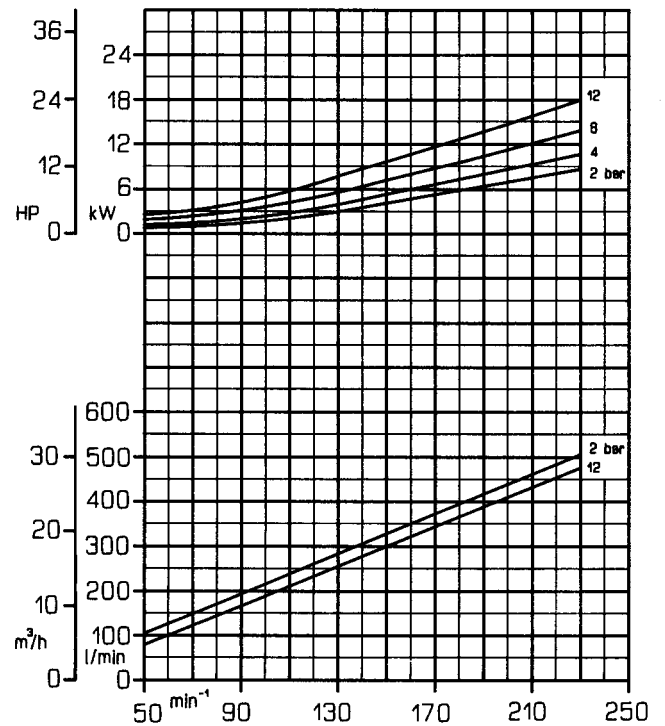

Viscosity: 20000 mm²/s (cSt)

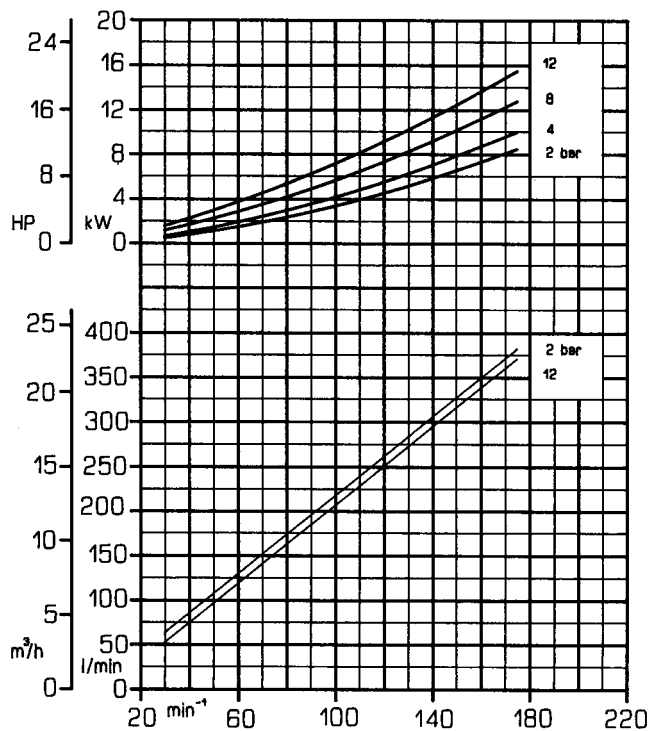

Viscosity: 60000 mm²/s (cSt)

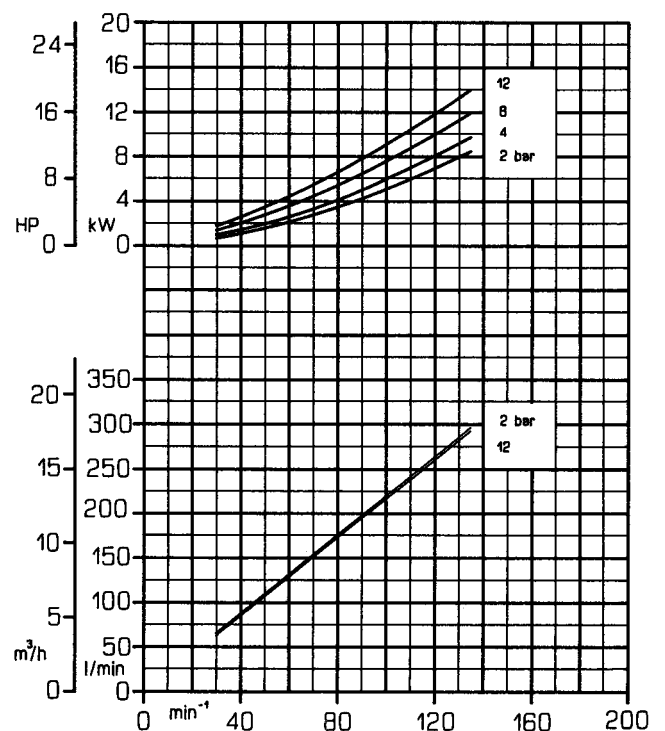

Performance curves



Viscosity range: from 20 to 600 mm²/s
 Displacement: 3,200 litres

Viscosity: 20 mm²/s (cSt)

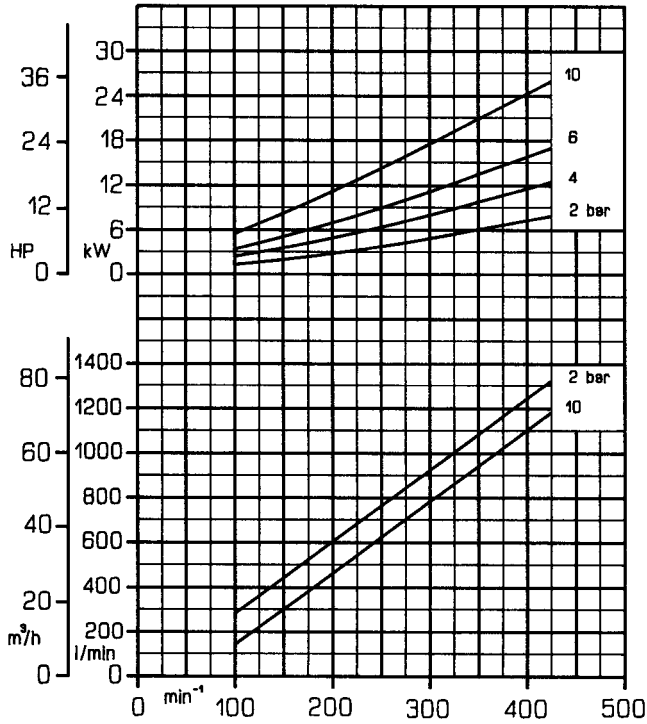

Viscosity: 60 mm²/s (cSt)

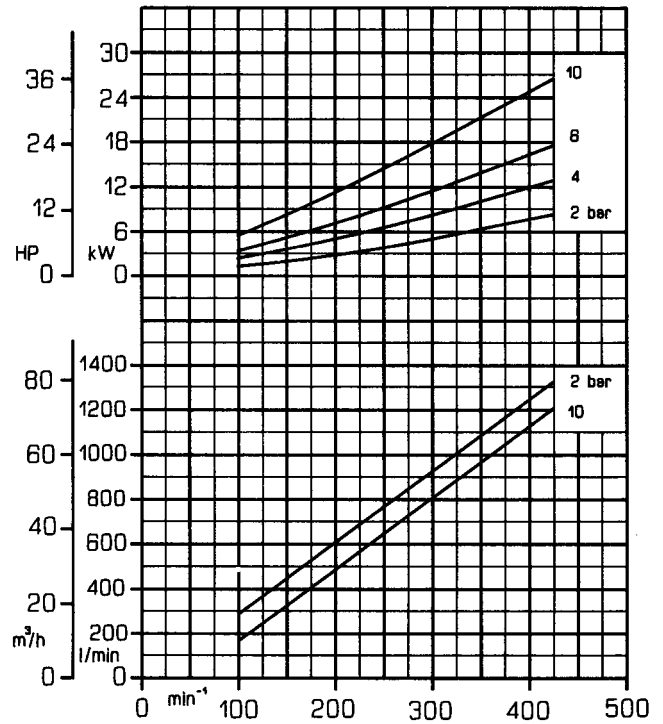

Viscosity: 200 mm²/s (cSt)

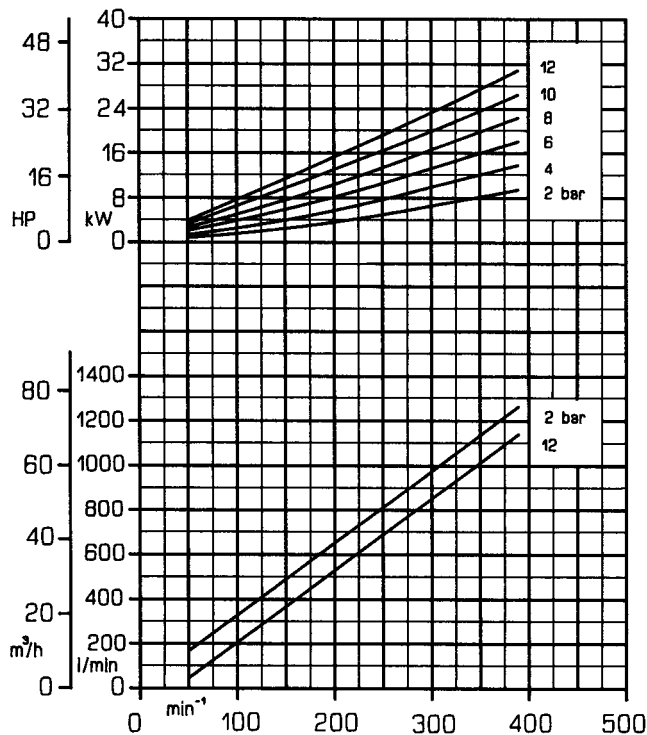

Viscosity: 600 mm²/s (cSt)

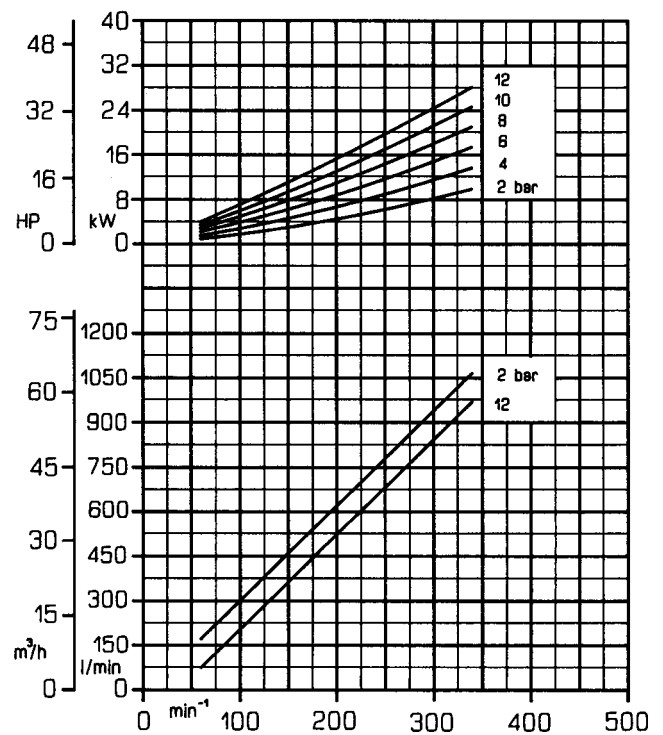

Viscosity: 2000 mm²/s (cSt)

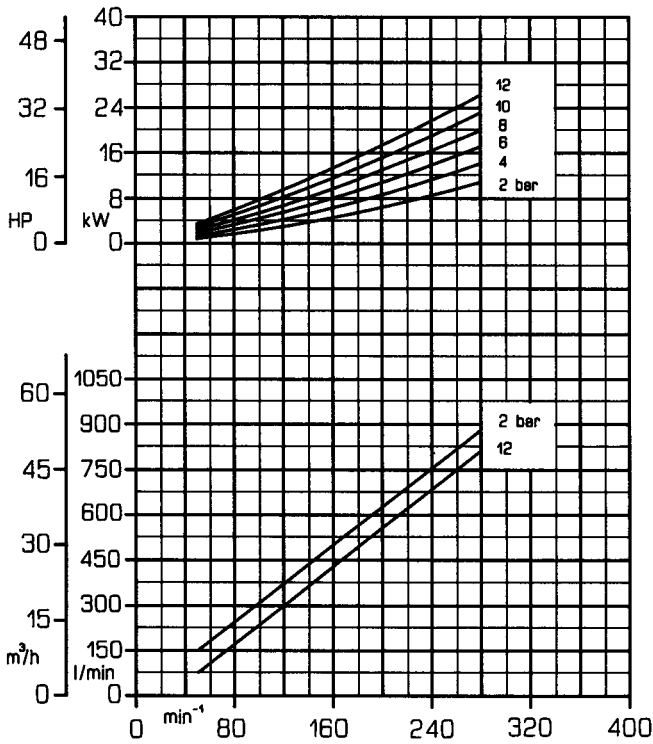

Viscosity: 6000 mm²/s (cSt)

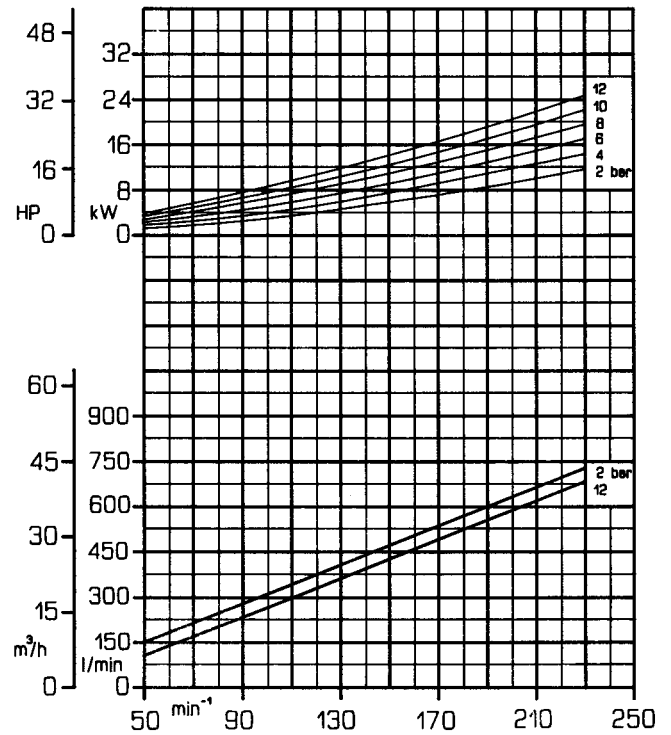

Viscosity: 20000 mm²/s (cSt)

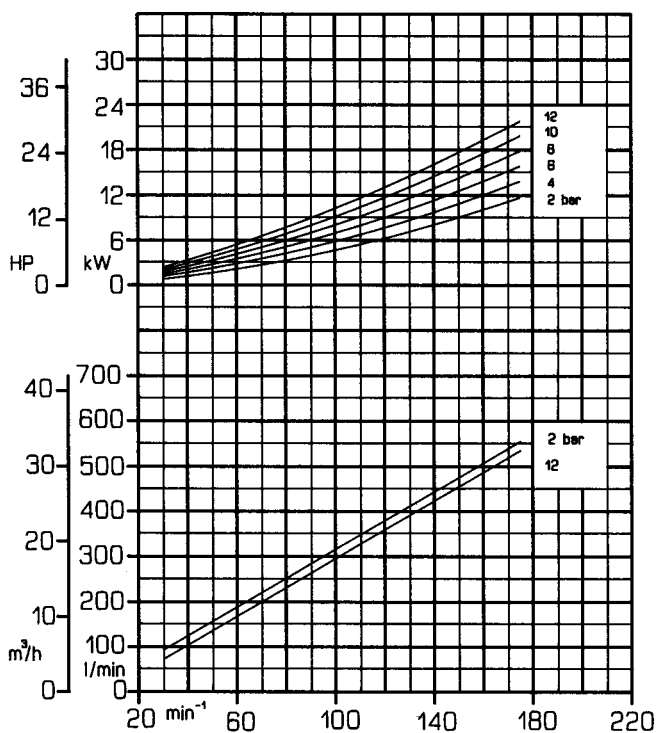

Viscosity: 60000 mm²/s (cSt)

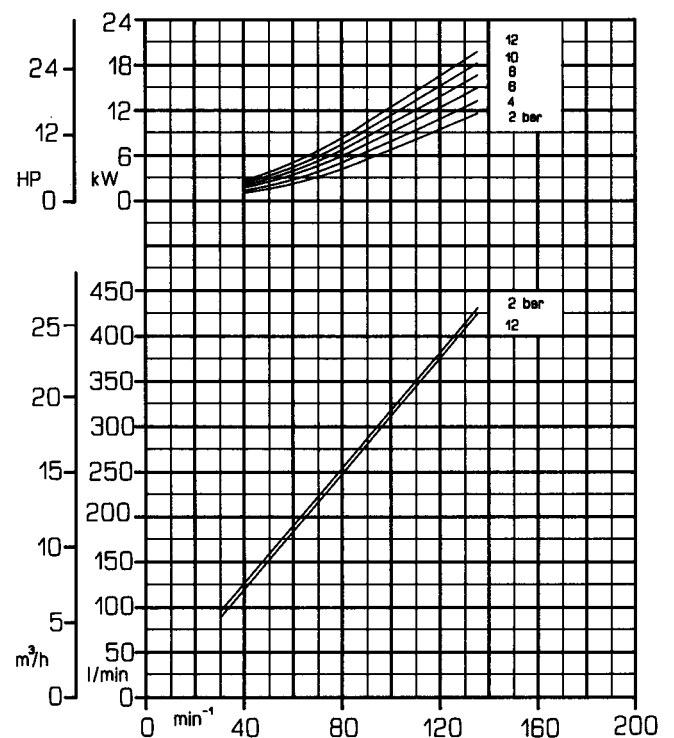

Performance curves



Viscosity range: from 20 to 600 mm²/s
 Displacement: 6,500 litres

Viscosity: 20 mm²/s (cSt)

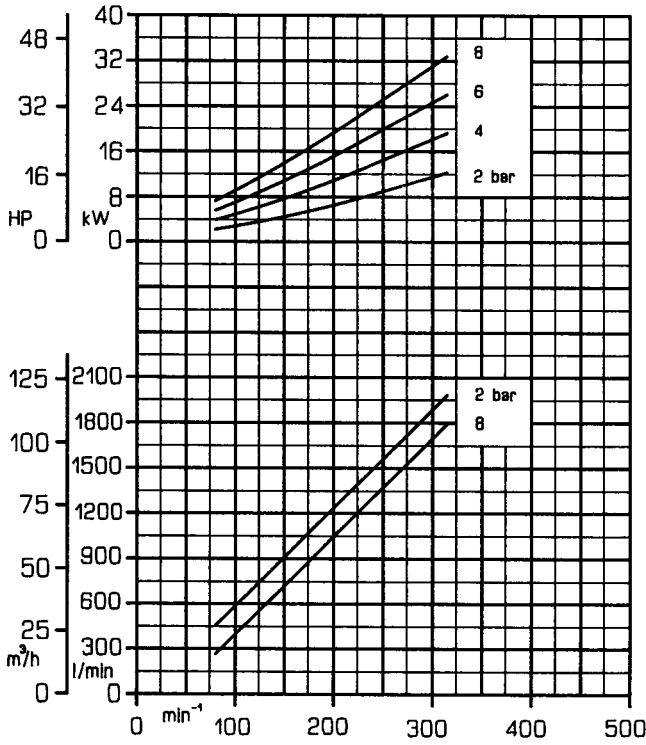

Viscosity: 60 mm²/s (cSt)

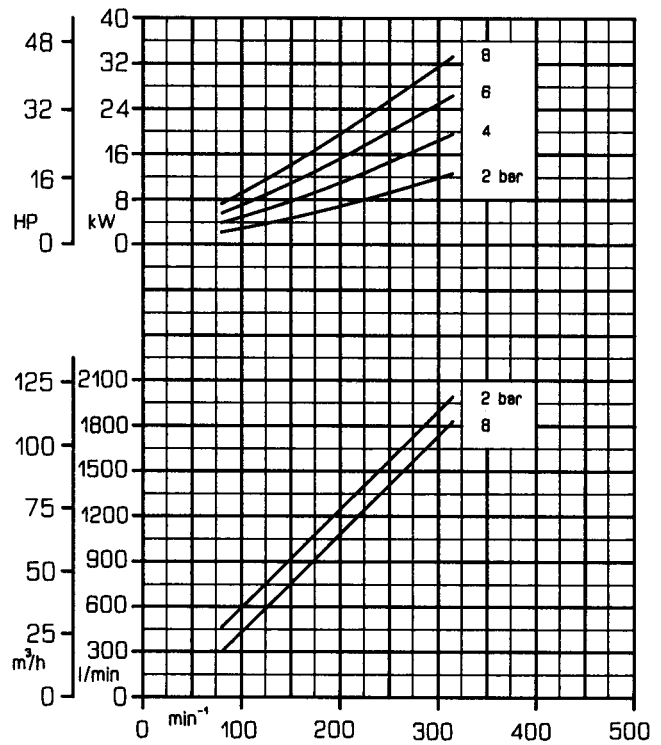

Viscosity: 200 mm²/s (cSt)

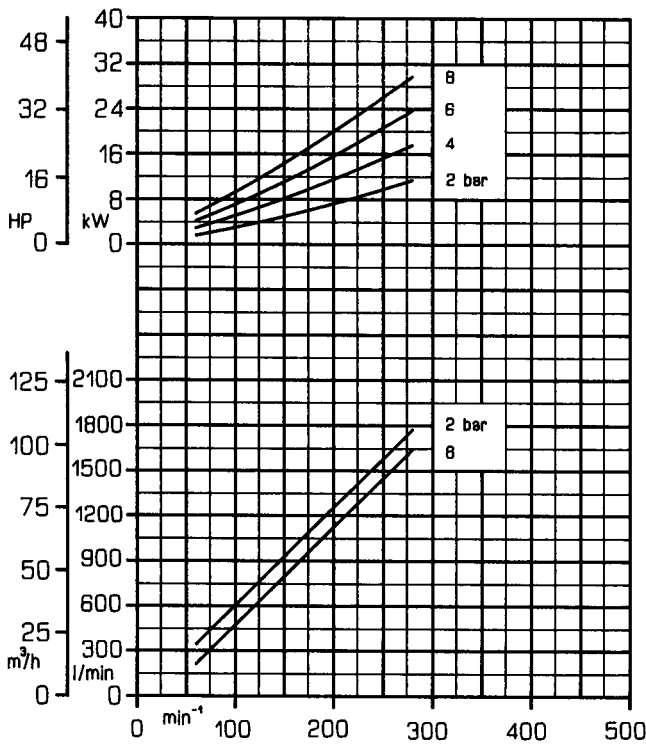

Viscosity: 600 mm²/s (cSt)

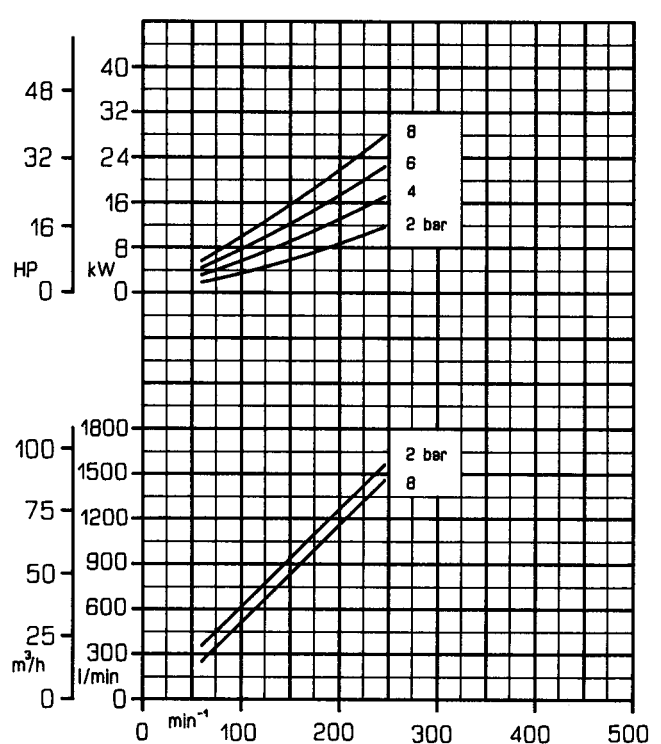

Viscosity: 2000 mm²/s (cSt)

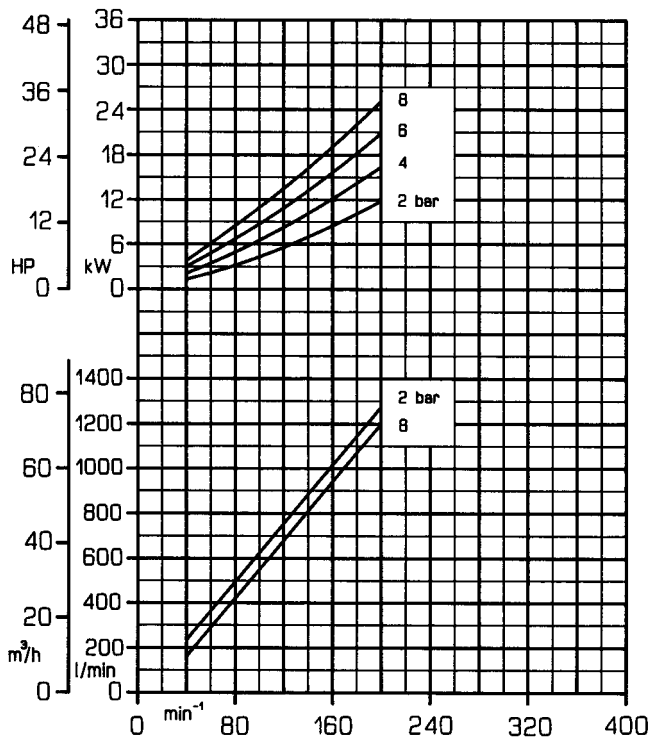

Viscosity: 6000 mm²/s (cSt)

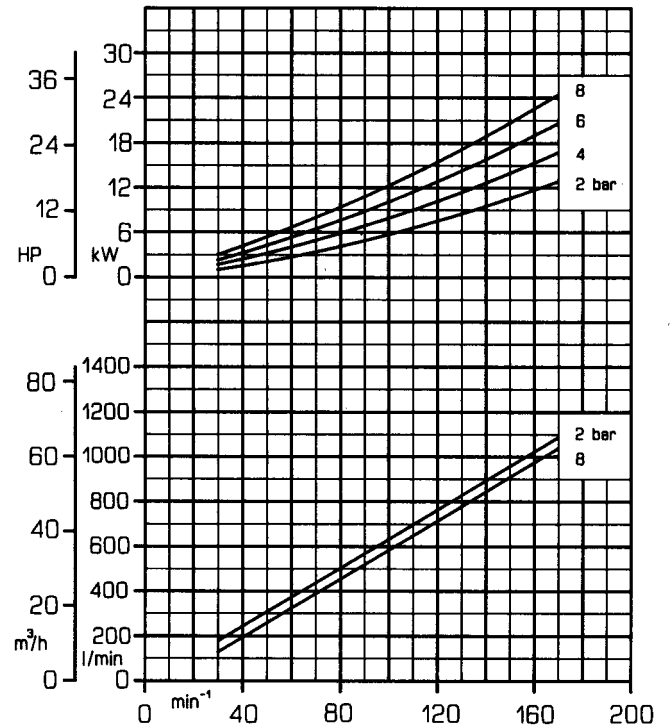

Viscosity: 20000 mm²/s (cSt)

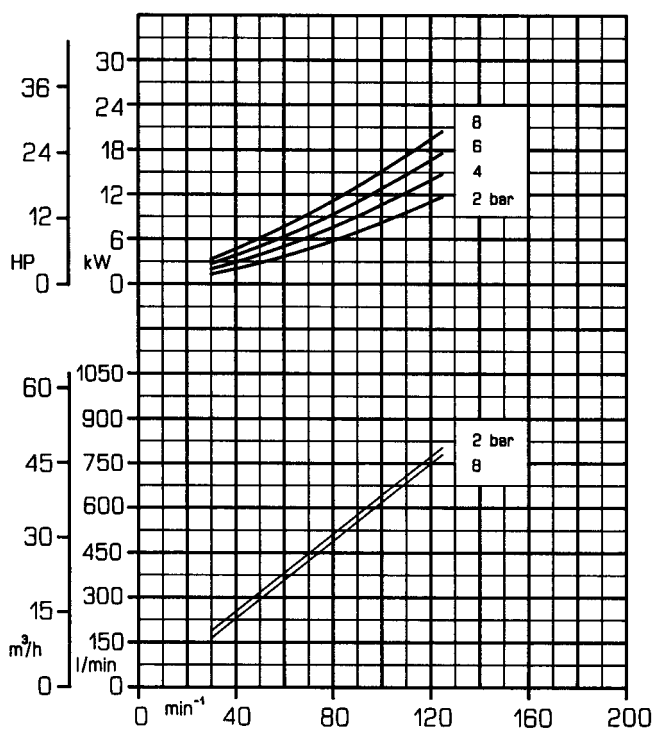

Viscosity: 60000 mm²/s (cSt)

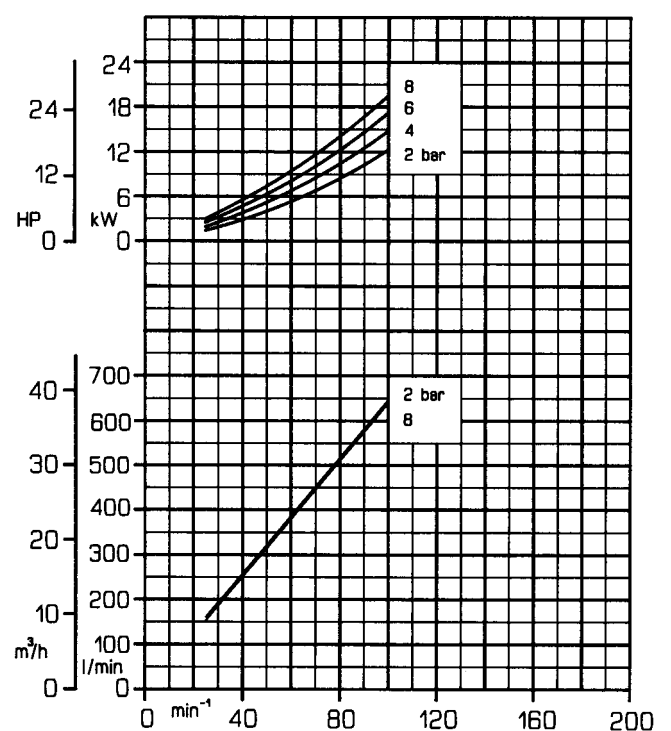

Performance curves



Viscosity range: from 20 to 600 mm²/s
 Displacement: 7,800 litres

Viscosity: 20 mm²/s (cSt)

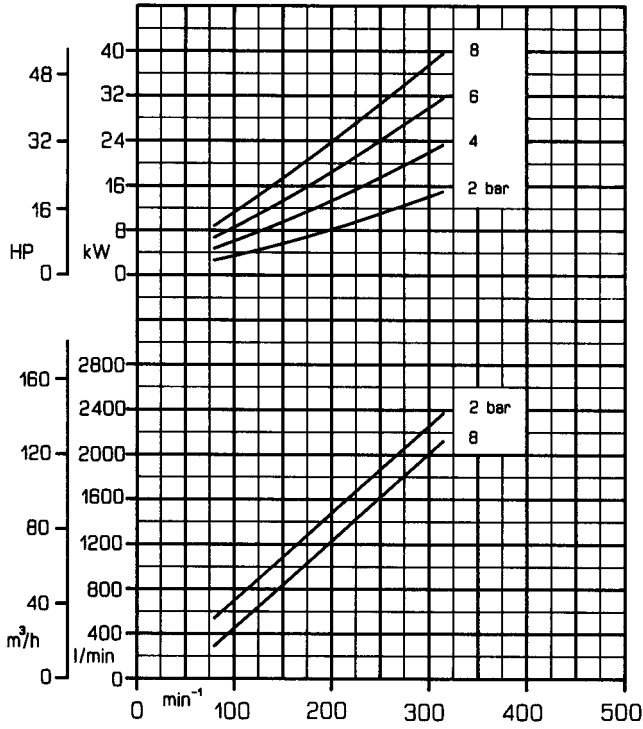

Viscosity: 60 mm²/s (cSt)

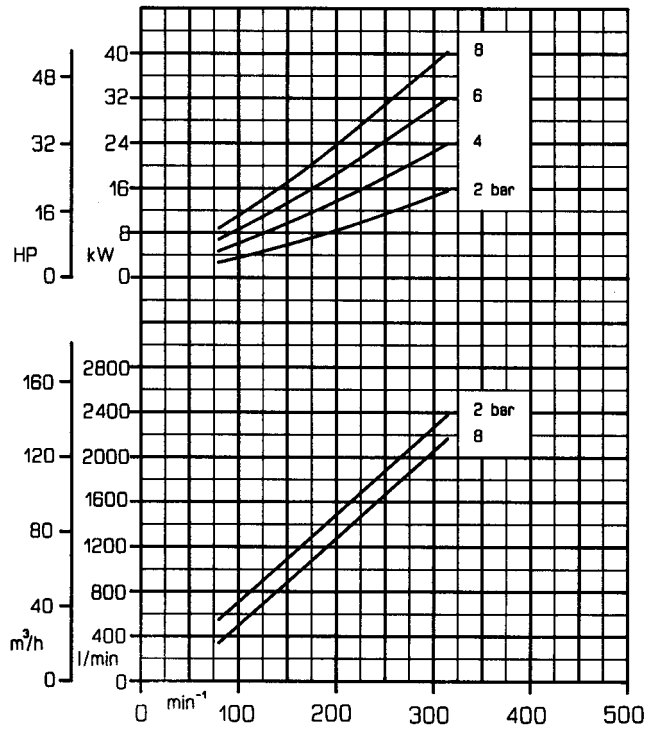

Viscosity: 200 mm²/s (cSt)

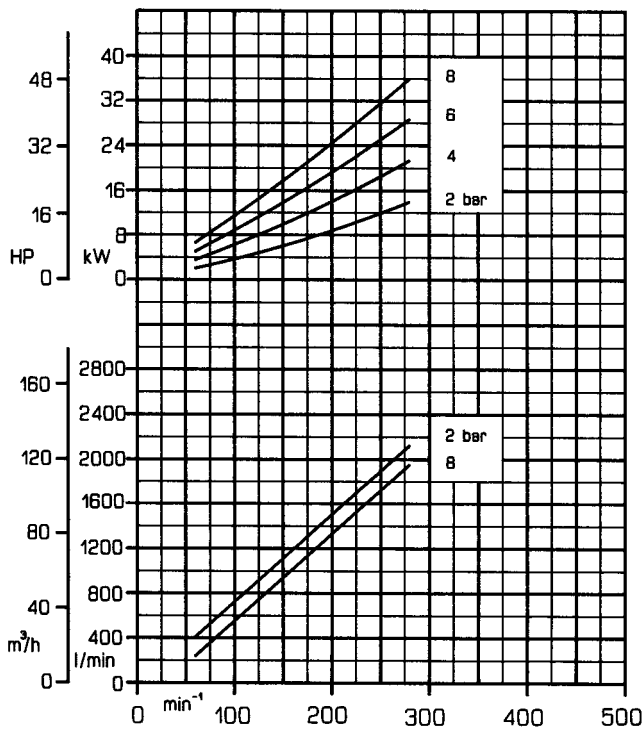

Viscosity: 600 mm²/s (cSt)

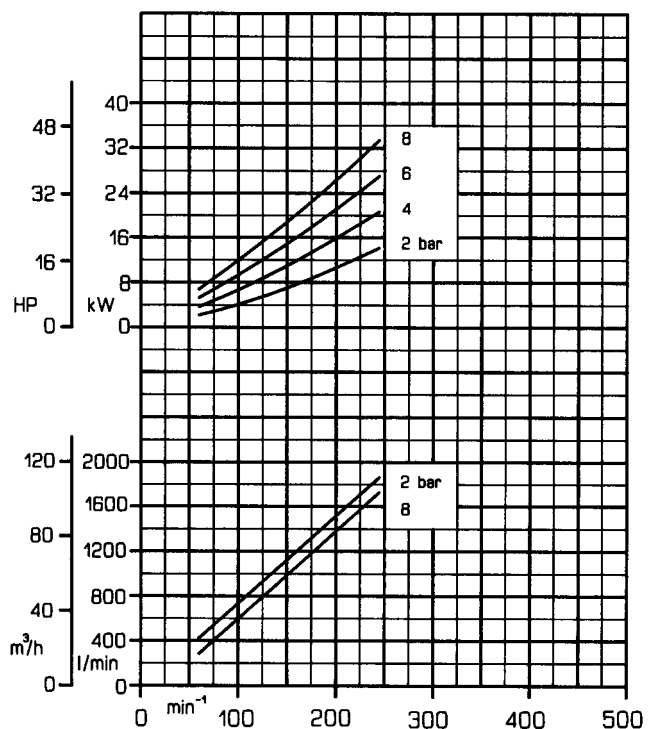

Viscosity: 2000 mm²/s (cSt)

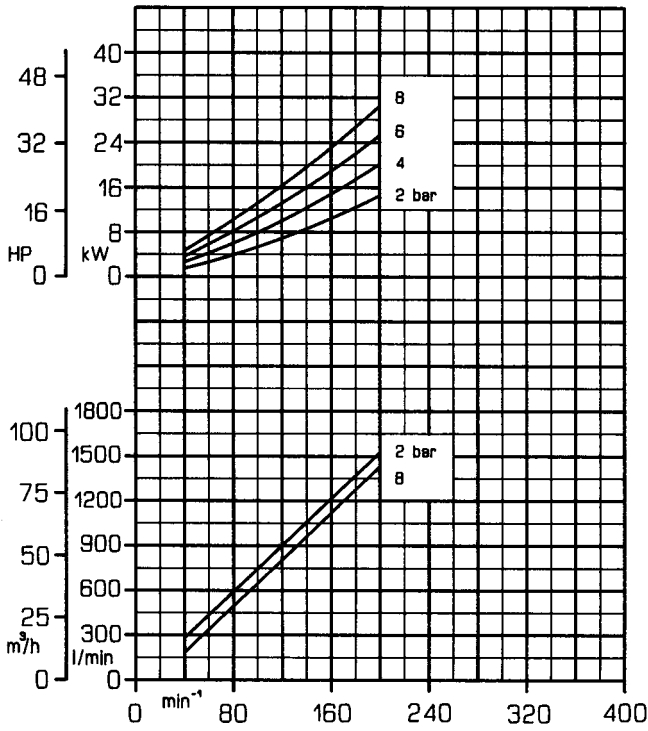

Viscosity: 6000 mm²/s (cSt)

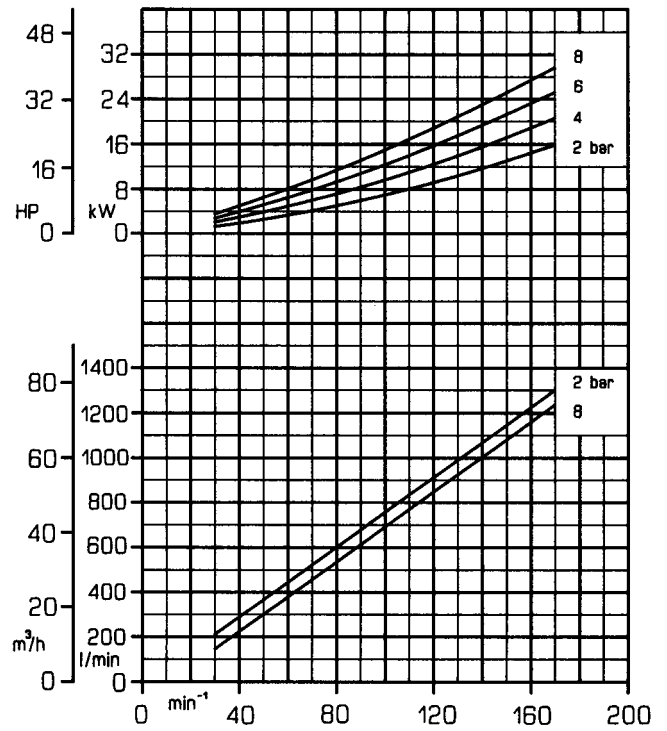

Viscosity: 20000 mm²/s (cSt)

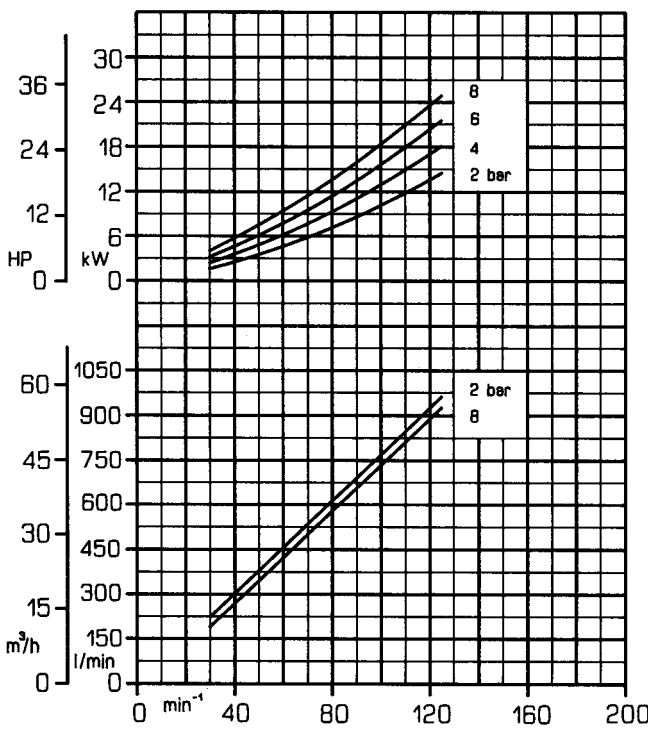

Viscosity: 60000 mm²/s (cSt)

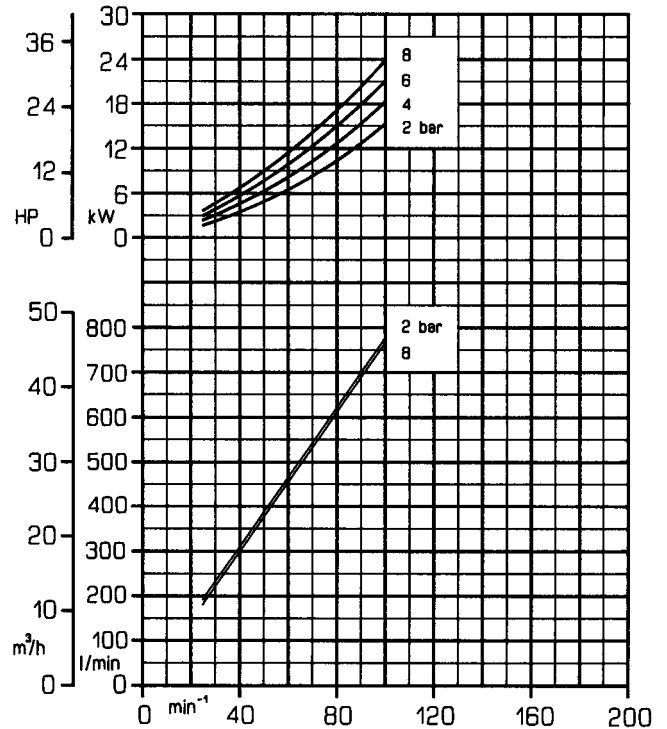

Performance curves



Viscosity range: from 20 to 600 mm²/s
 Displacement: 6,500 litres

Viscosity: 20 mm²/s (cSt)

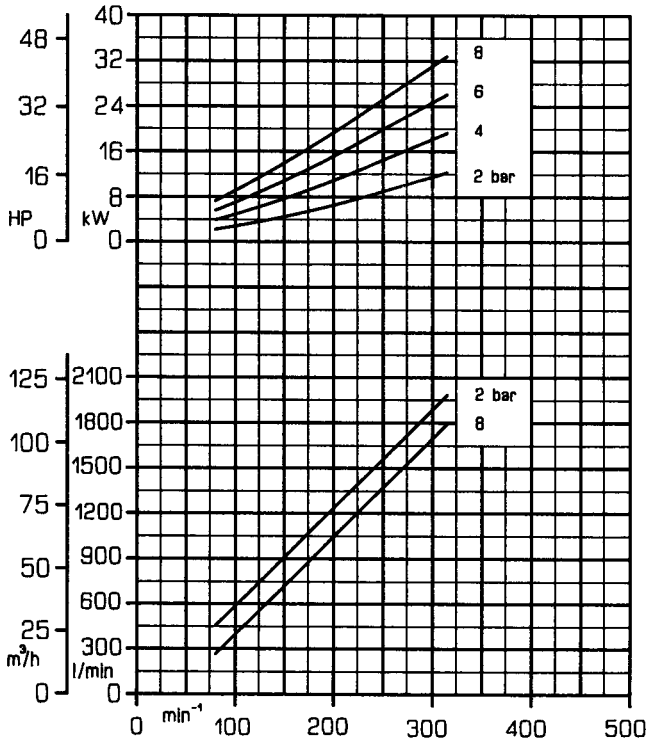

Viscosity: 60 mm²/s (cSt)

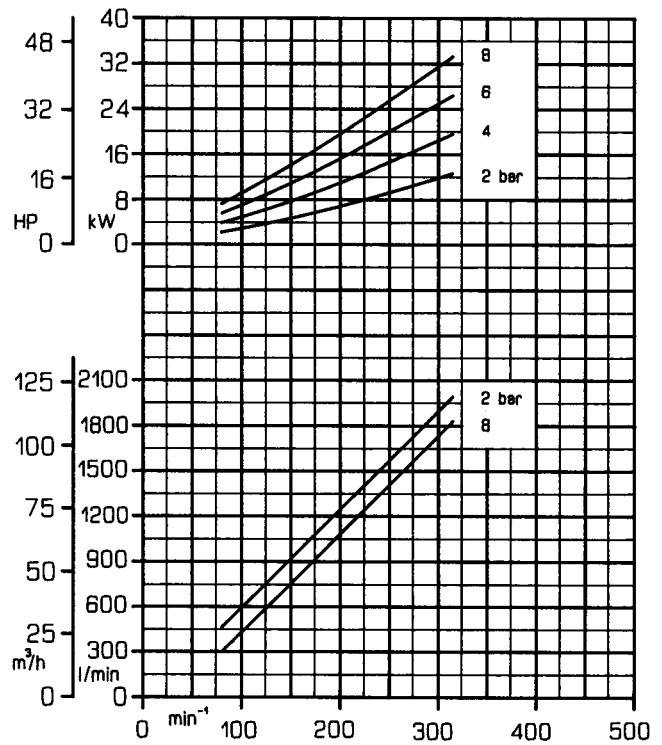

Viscosity: 200 mm²/s (cSt)

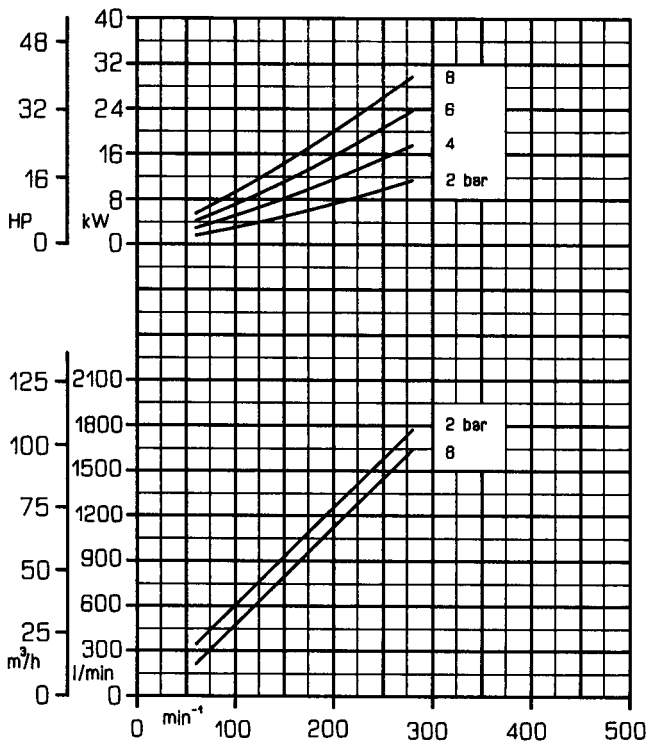

Viscosity: 600 mm²/s (cSt)

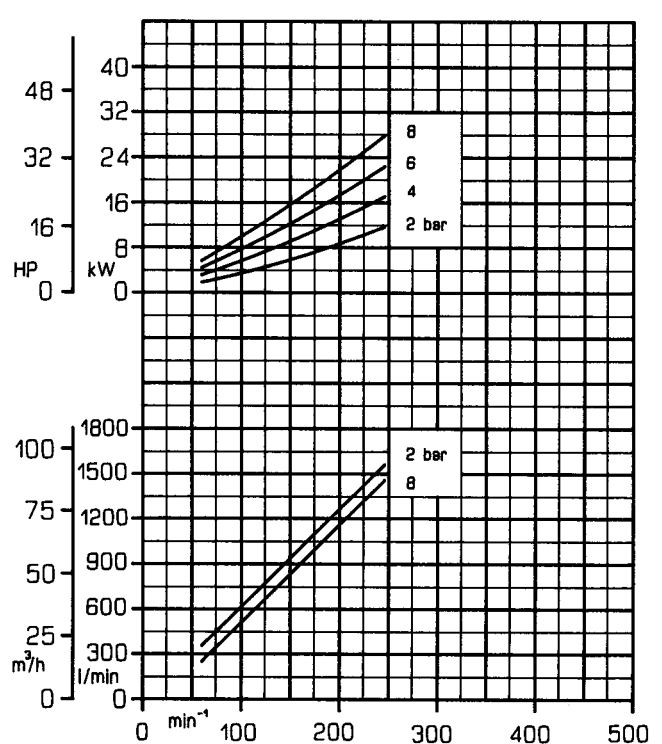

Viscosity: 2000 mm²/s (cSt)

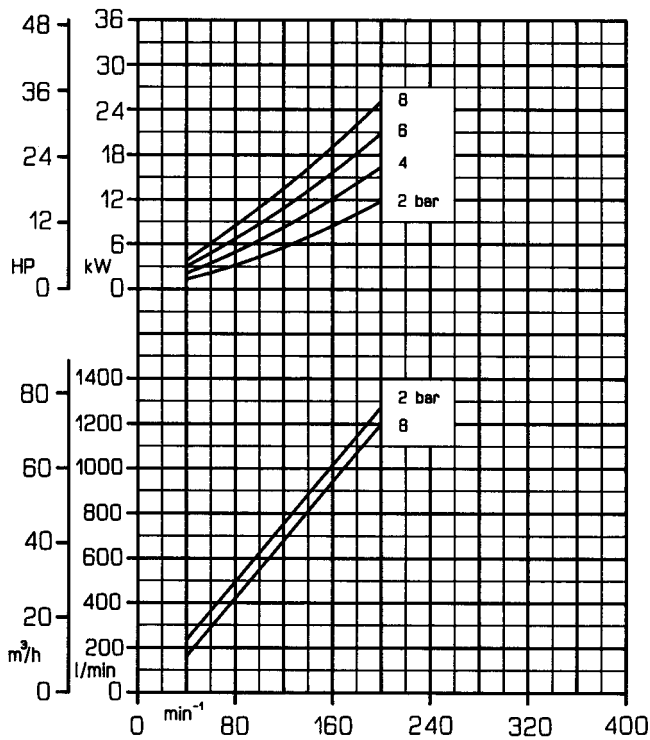

Viscosity: 6000 mm²/s (cSt)

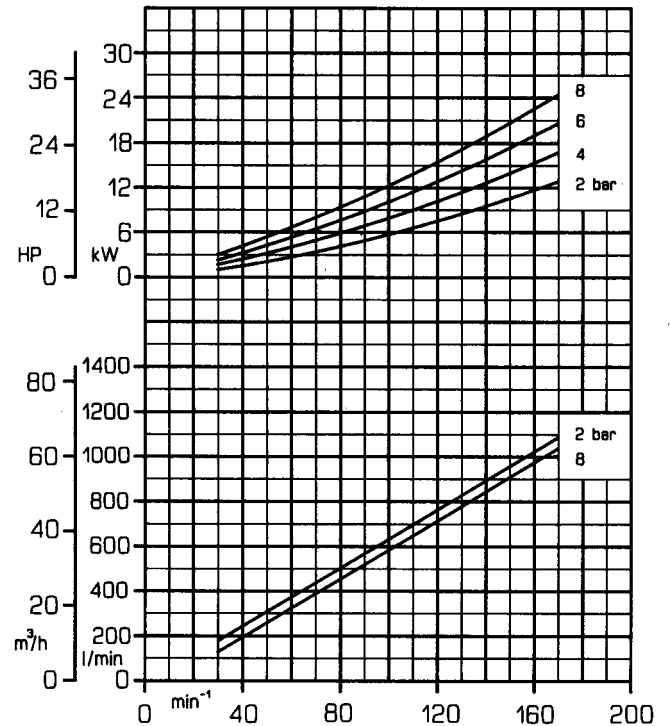

Viscosity: 20000 mm²/s (cSt)

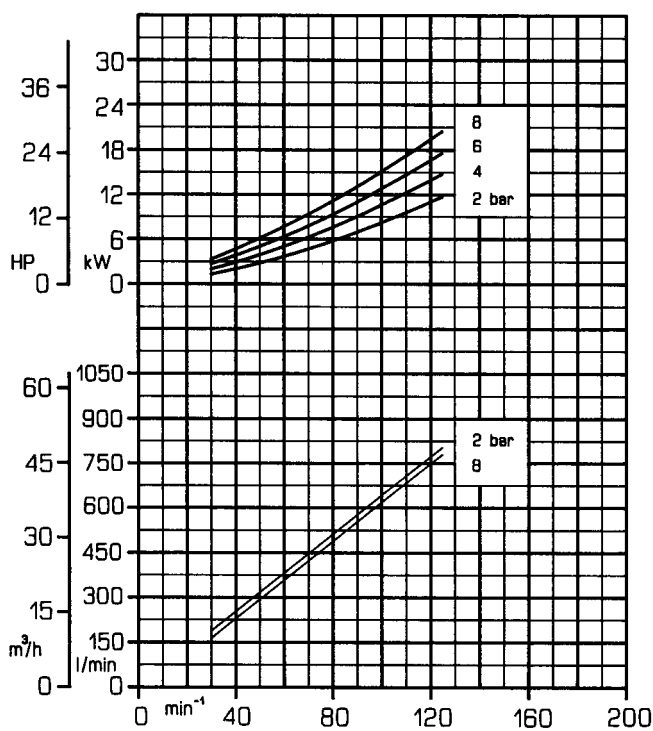

Viscosity: 60000 mm²/s (cSt)

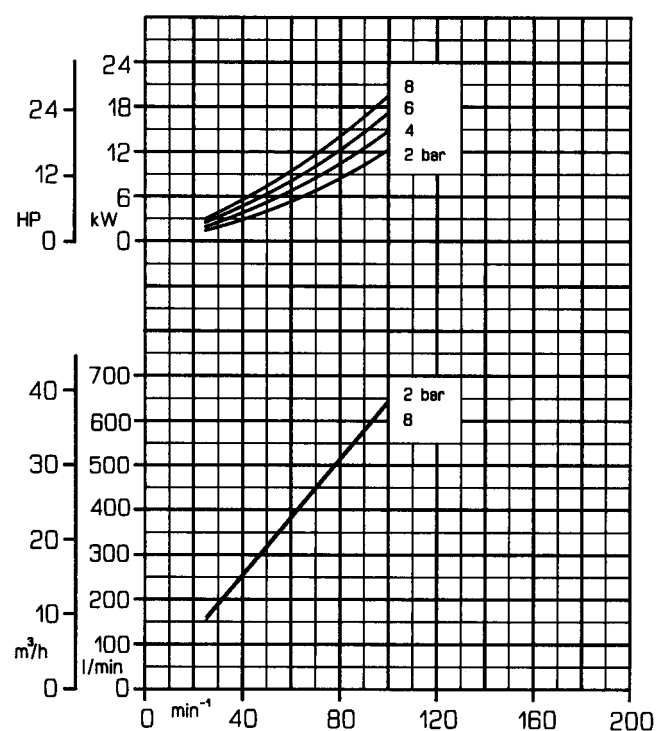

Performance curves



Viscosity: 20 mm²/s
Displacement: 12,400 litres

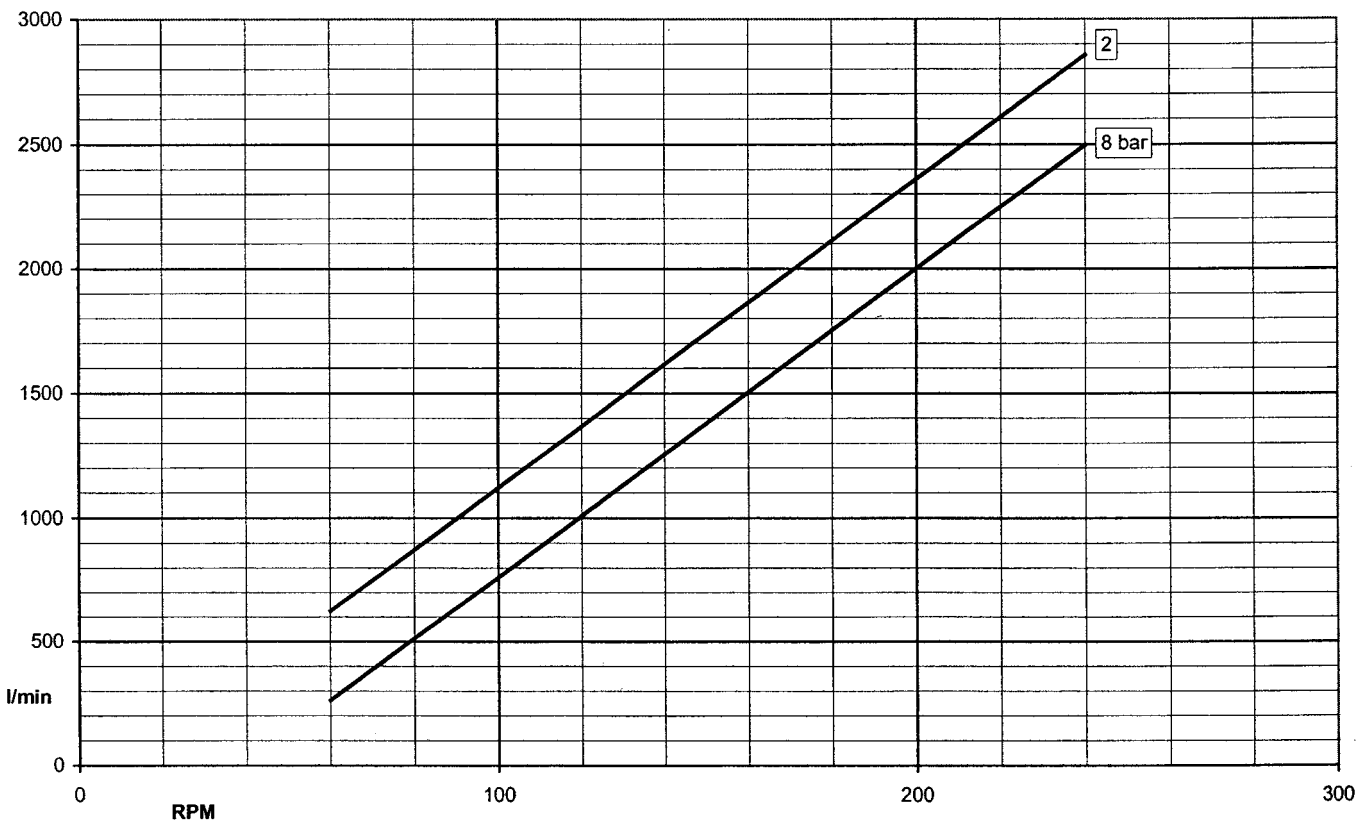
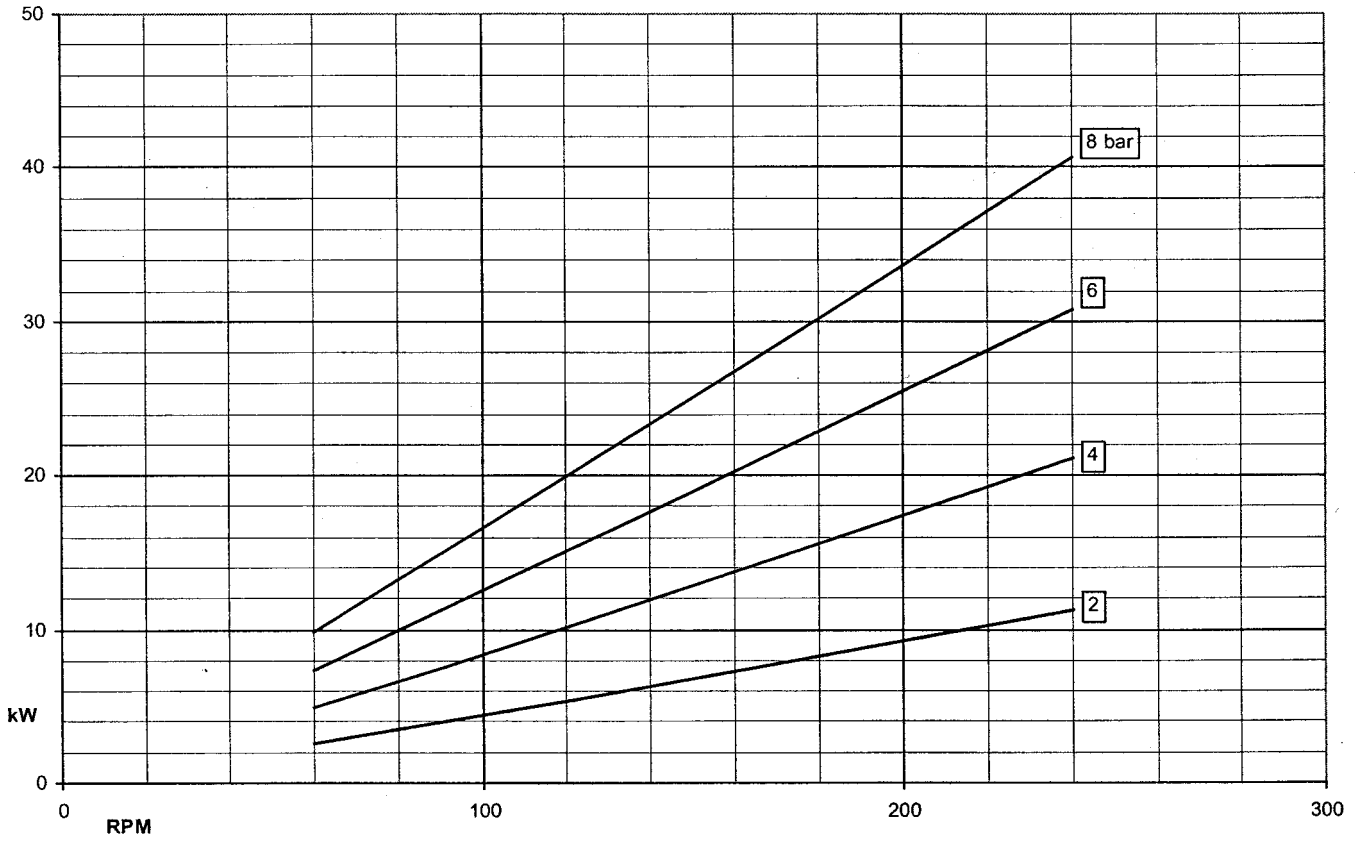

Viscosity: 60 mm²/s
Displacement: 12,400 litres

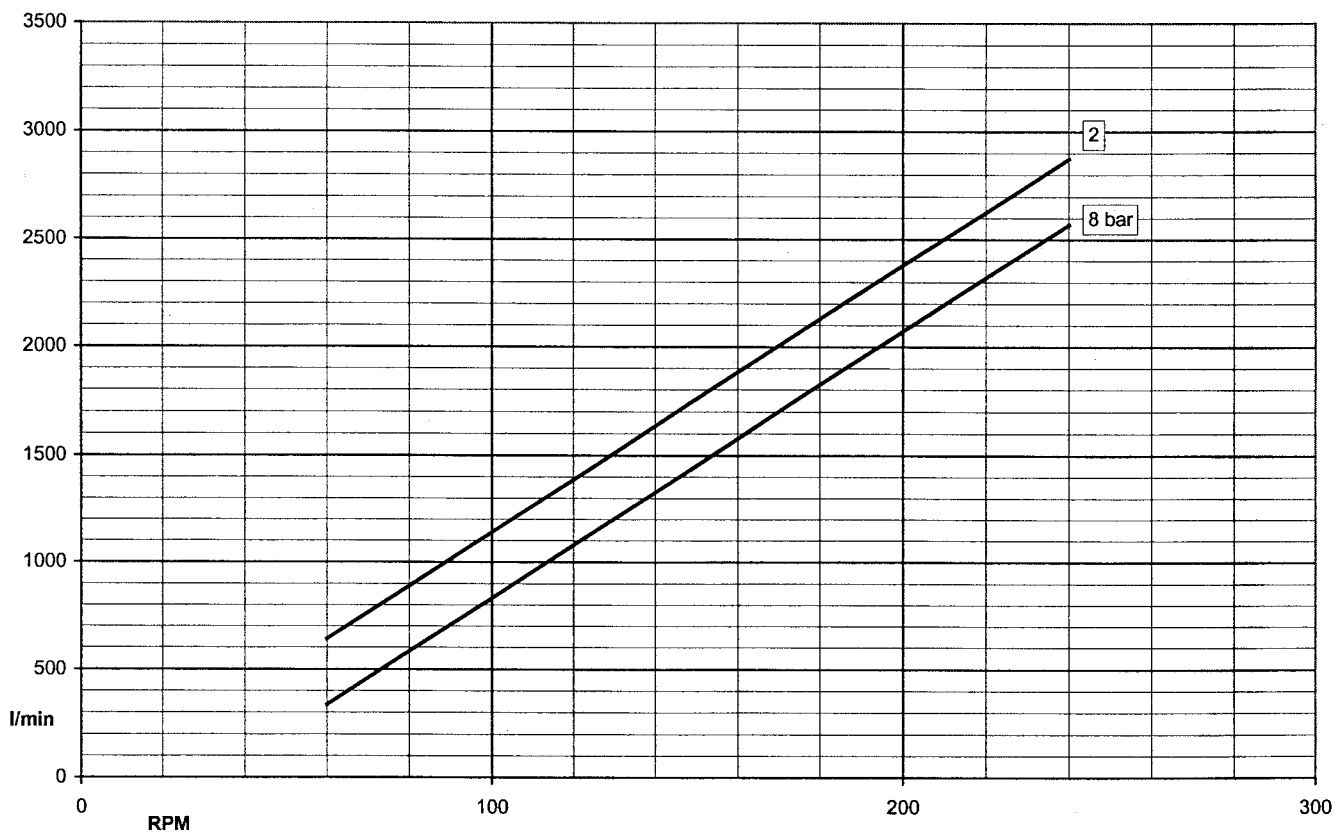
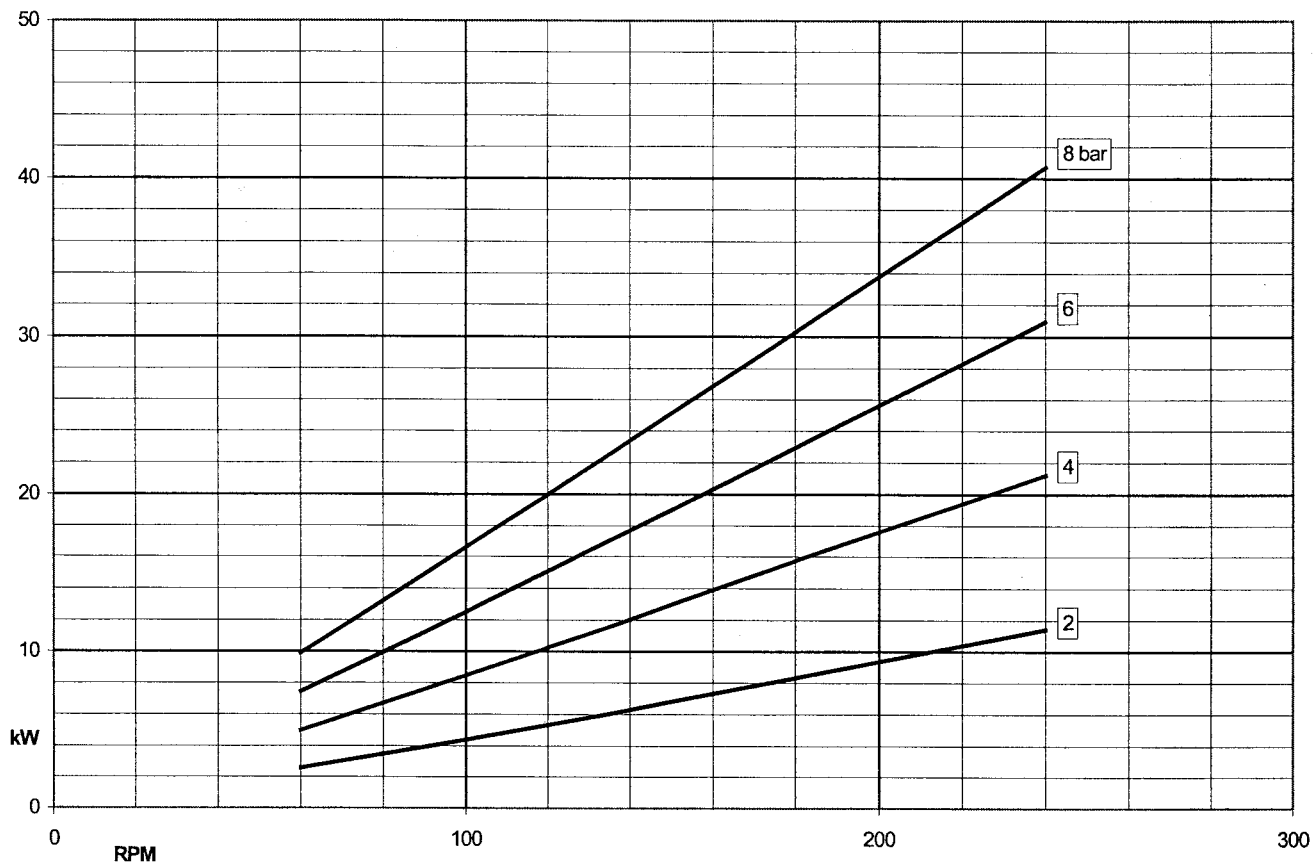

V180

Pag. 50 / 57

04 11 - Rev. 00

Performance curves



Viscosity: 200 mm²/s
Displacement: 12,400 litres

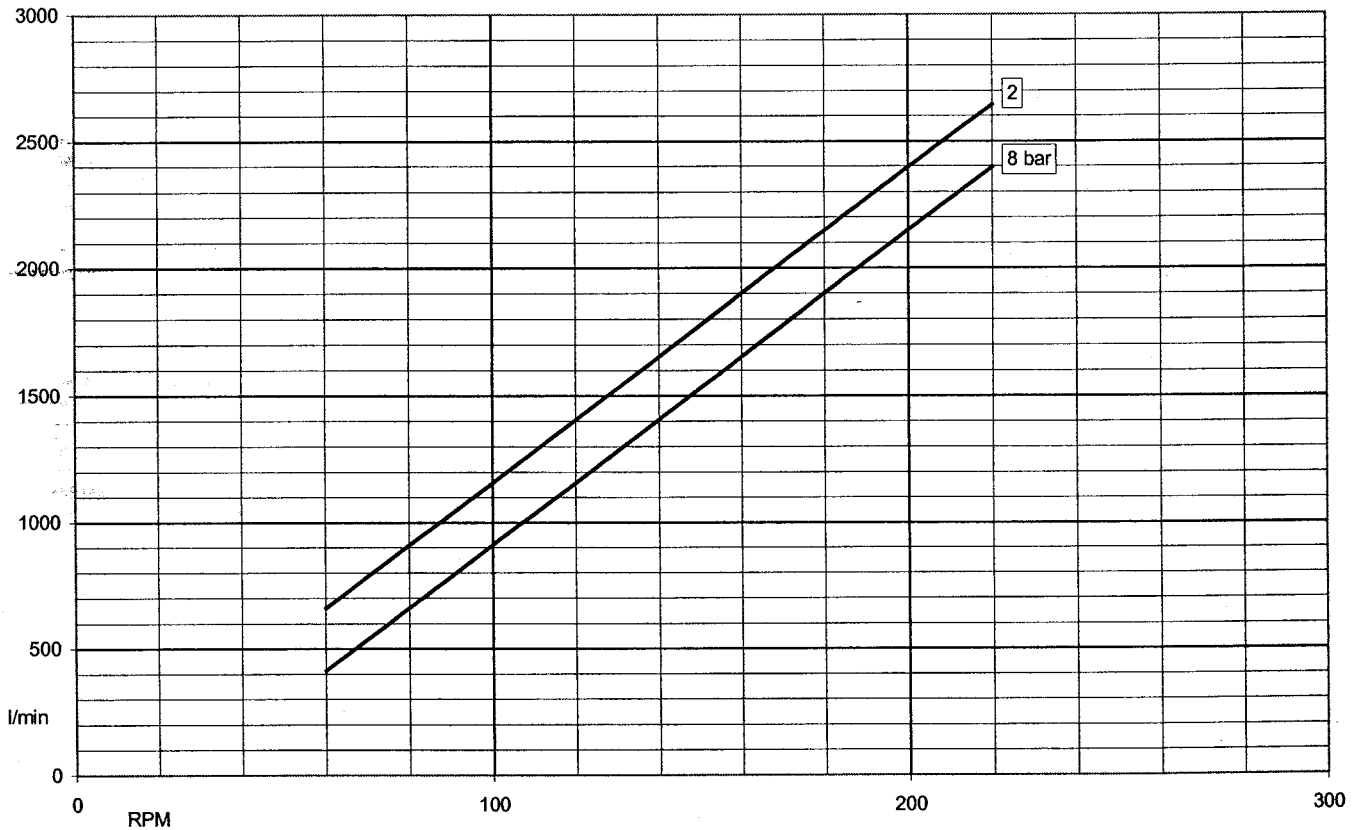
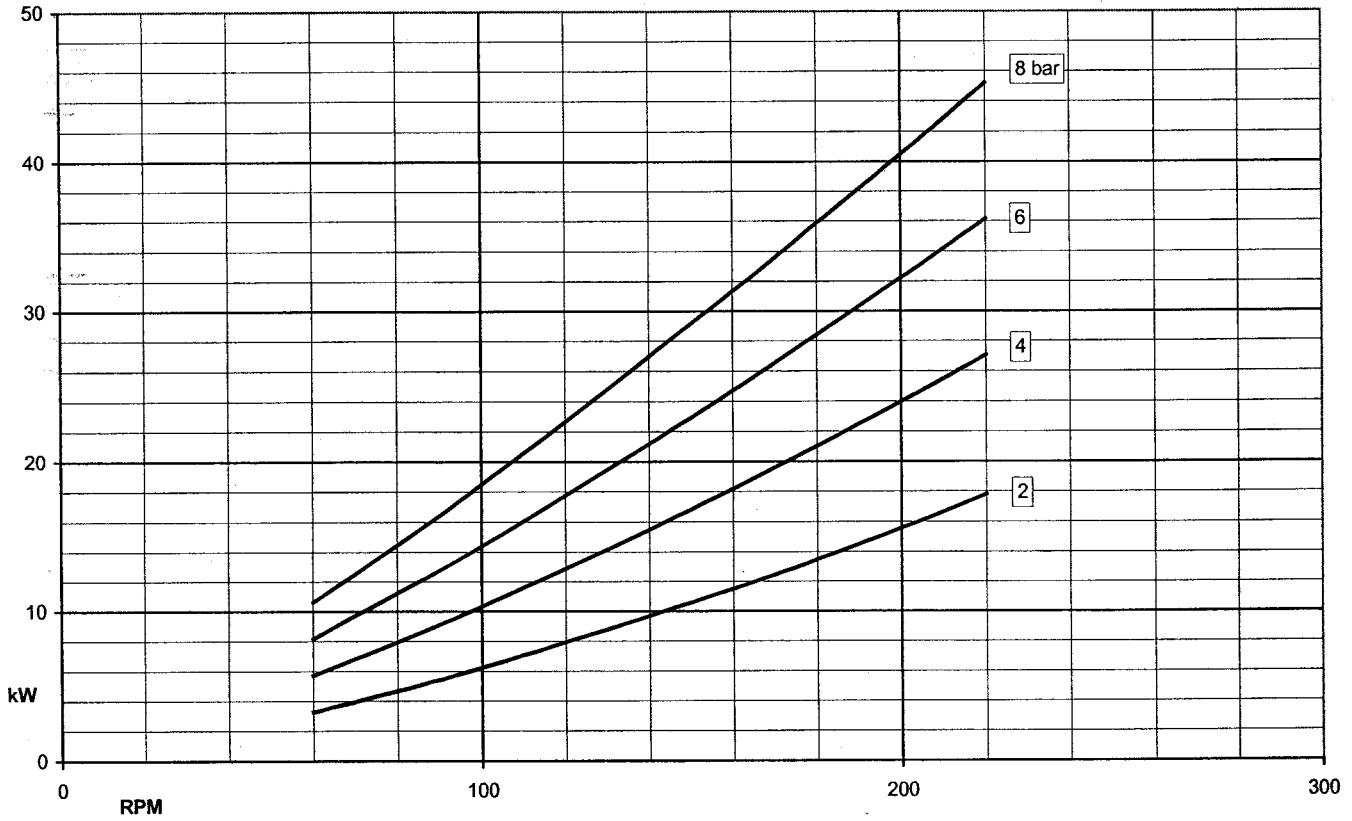

Viscosity: 600 mm²/s
Displacement: 12,400 litres

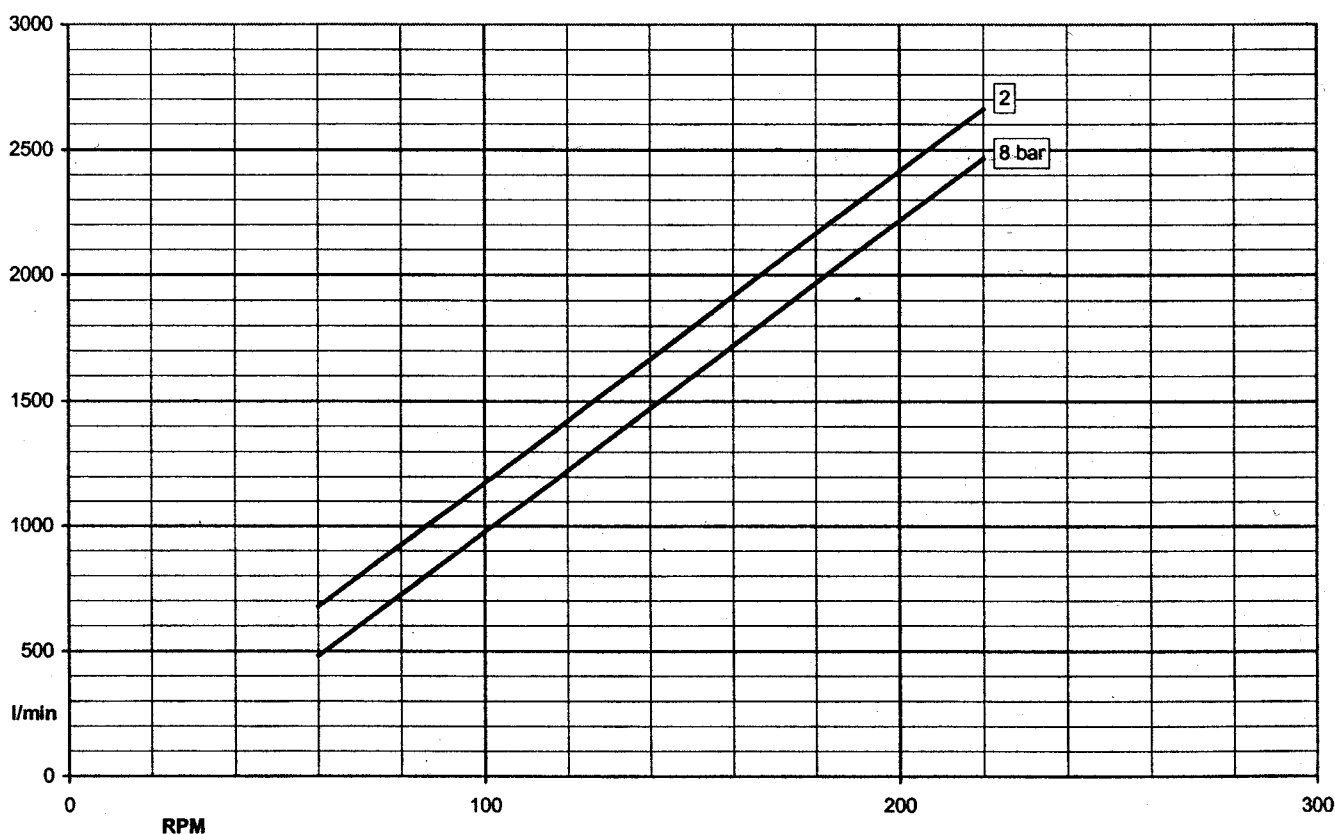
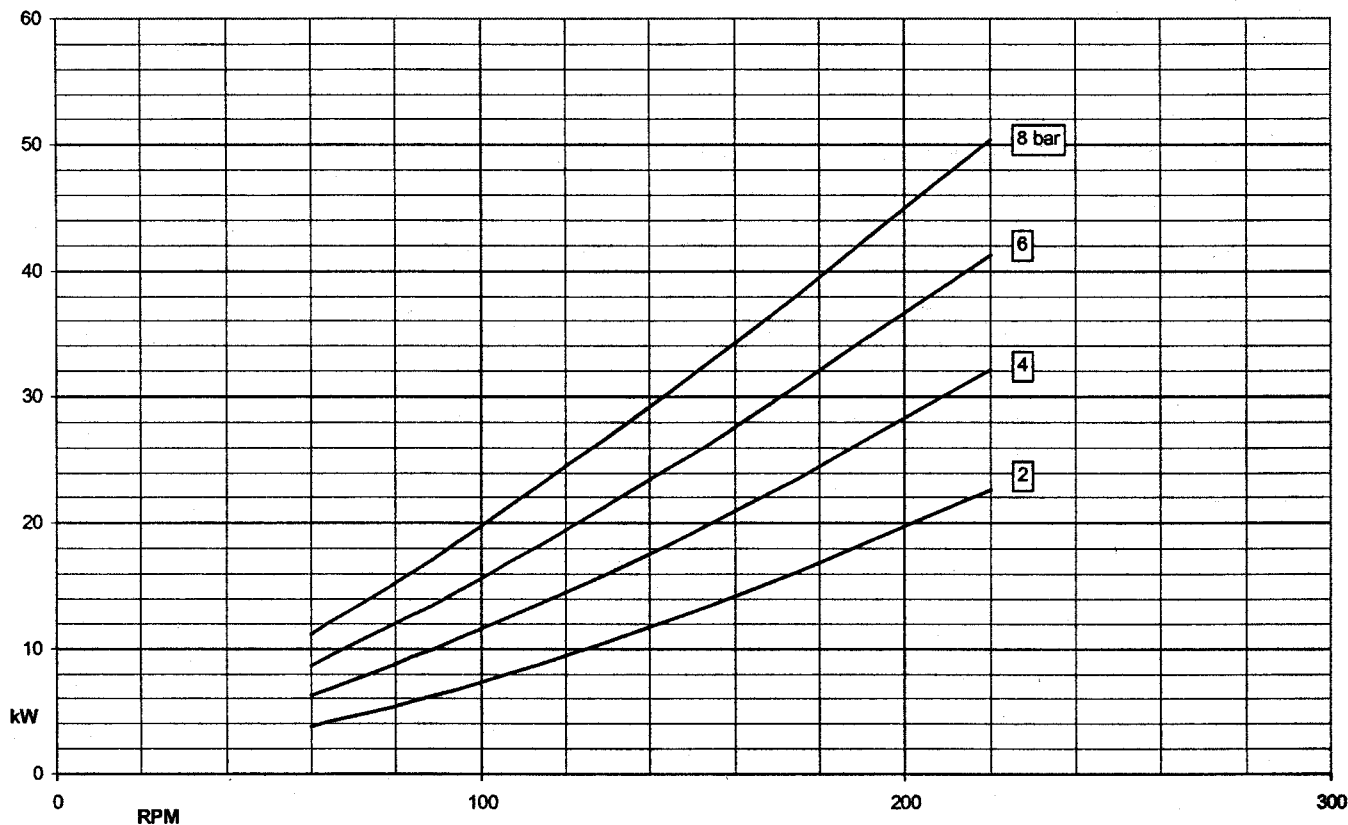

Performance curves



Viscosity: 2000 mm²/s
Displacement: 12,400 litres

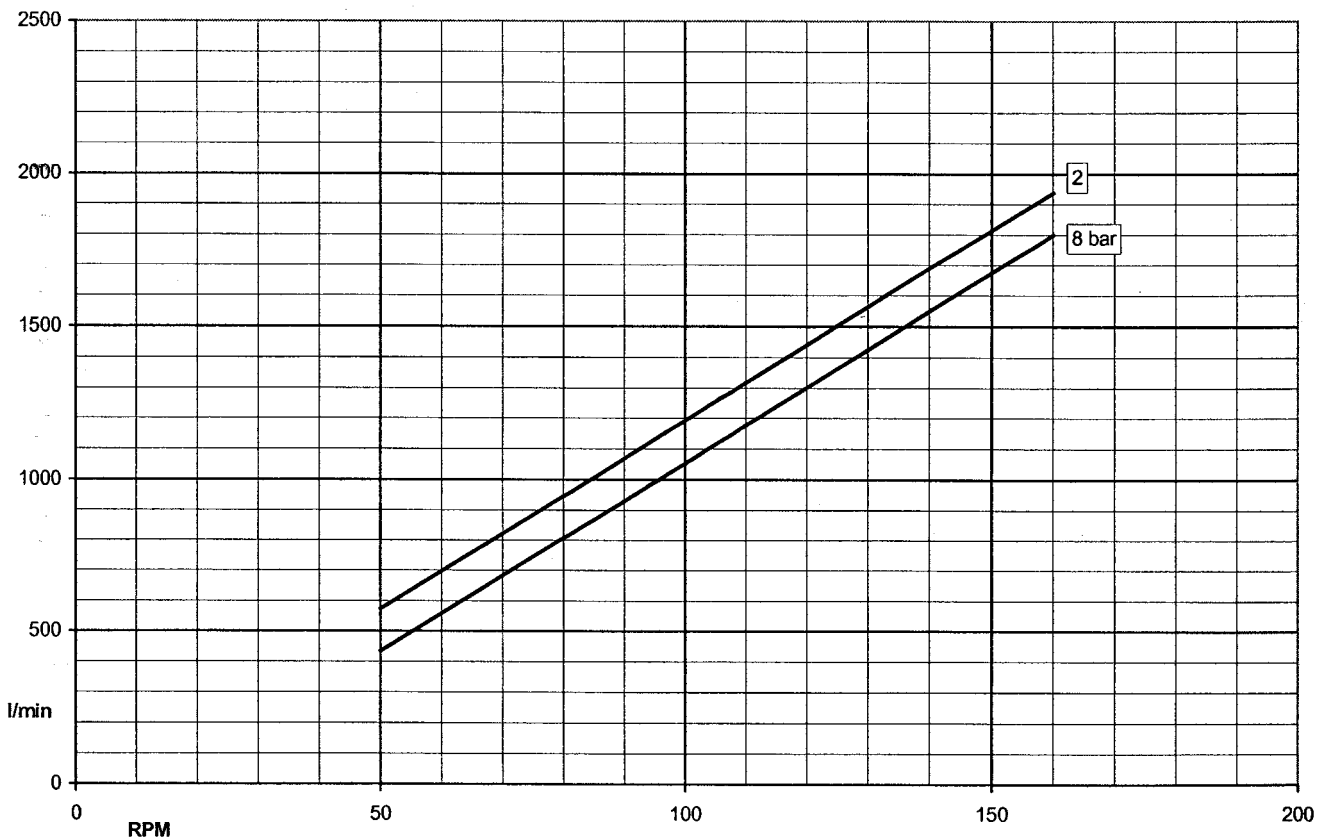
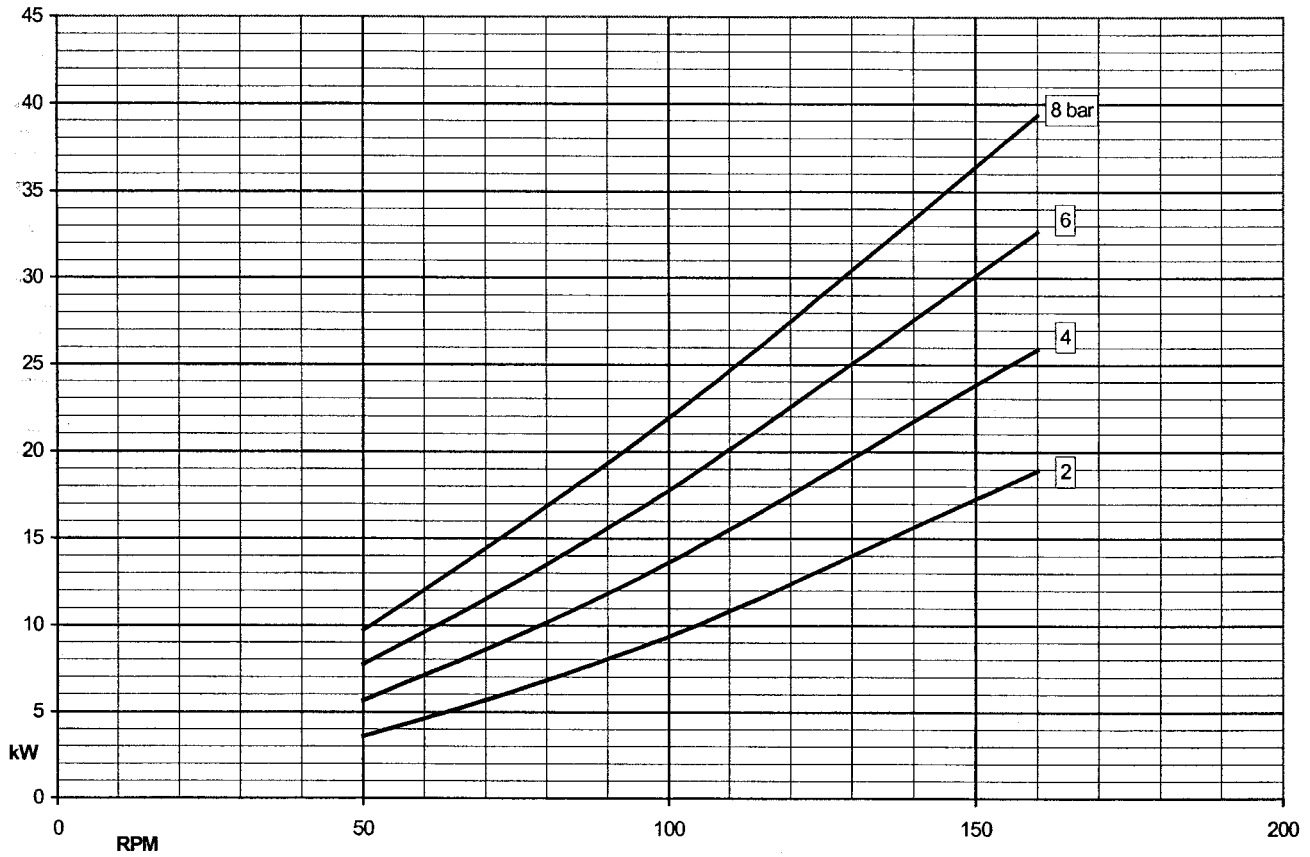

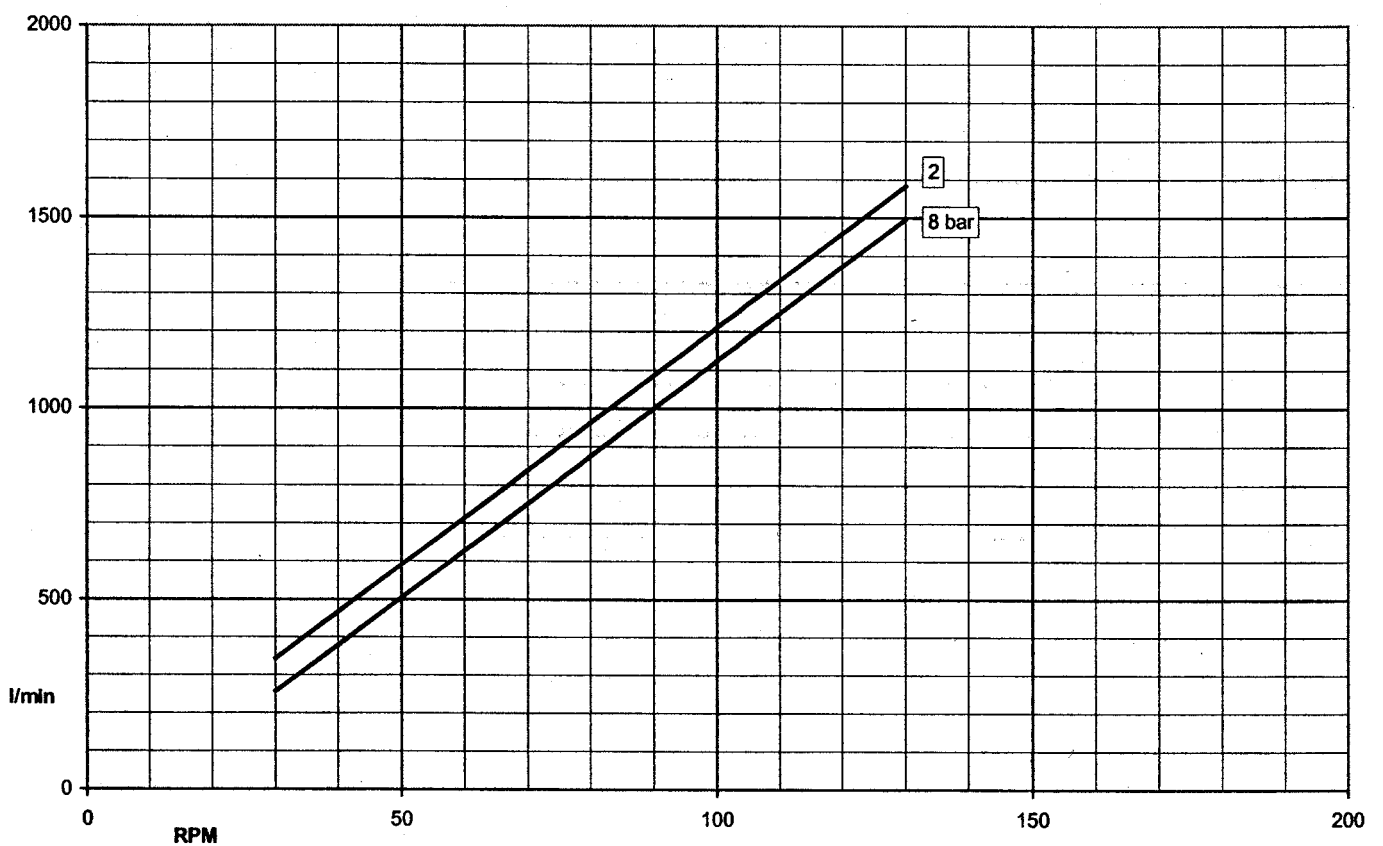
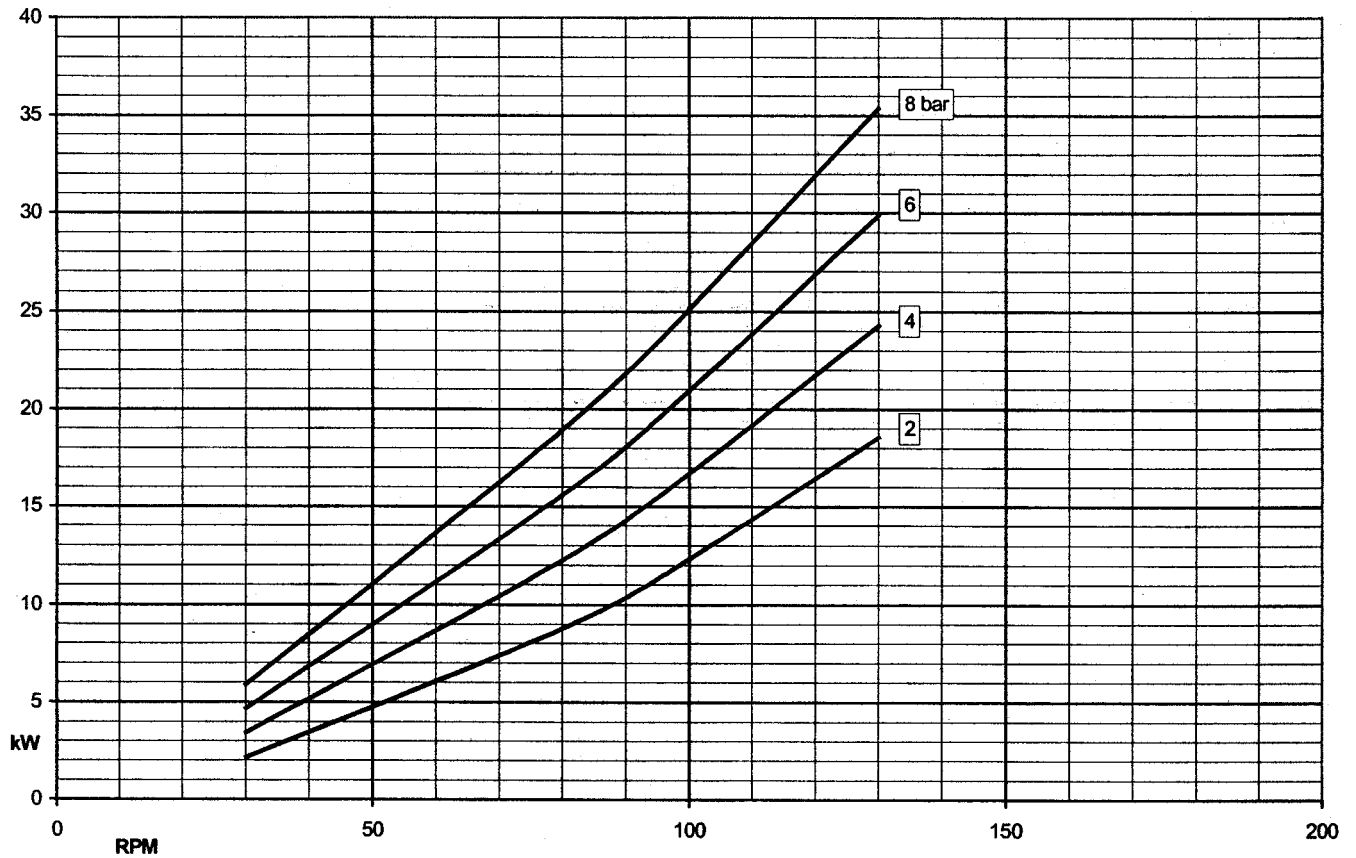

Performance curves

Viscosity: 20.000 mm²/s
Displacement: 12,400 litres

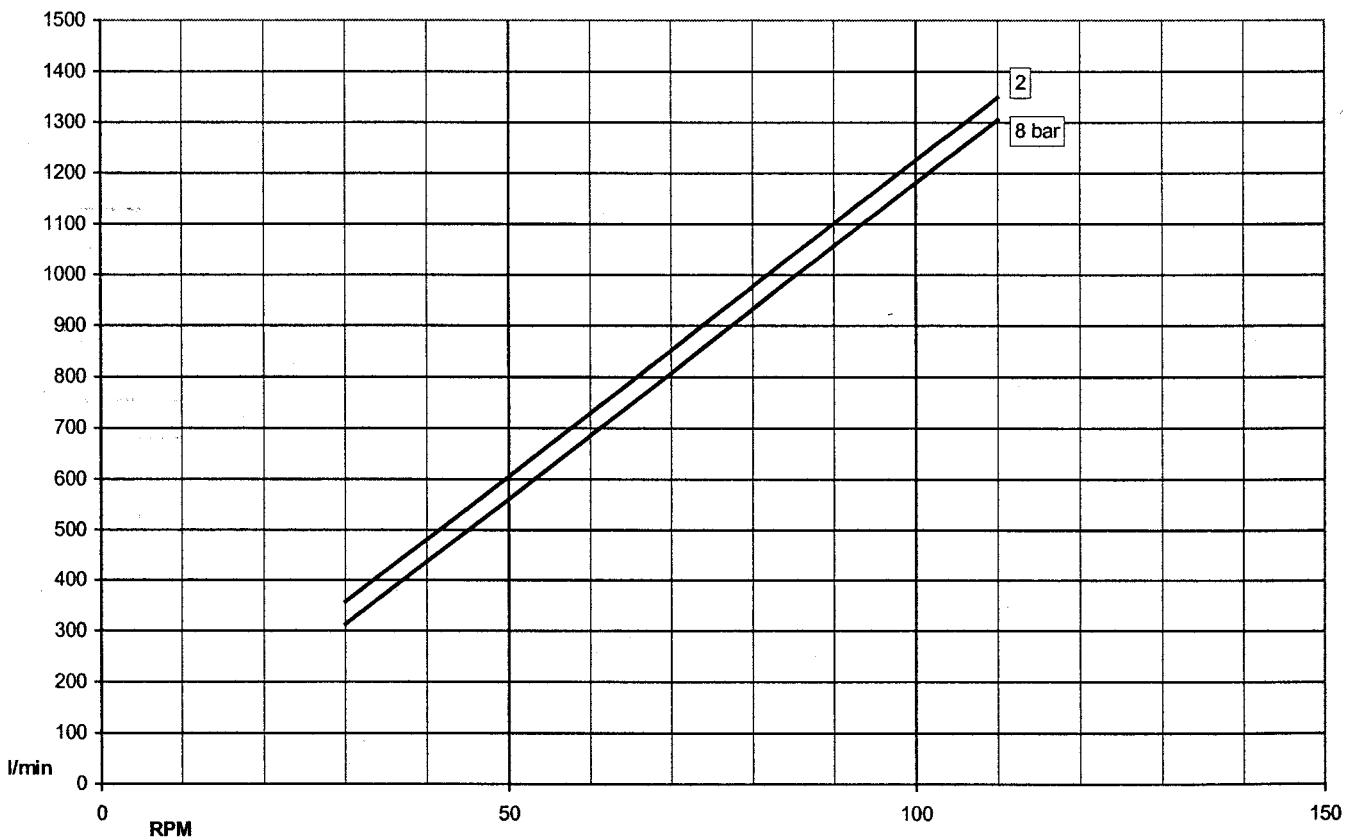
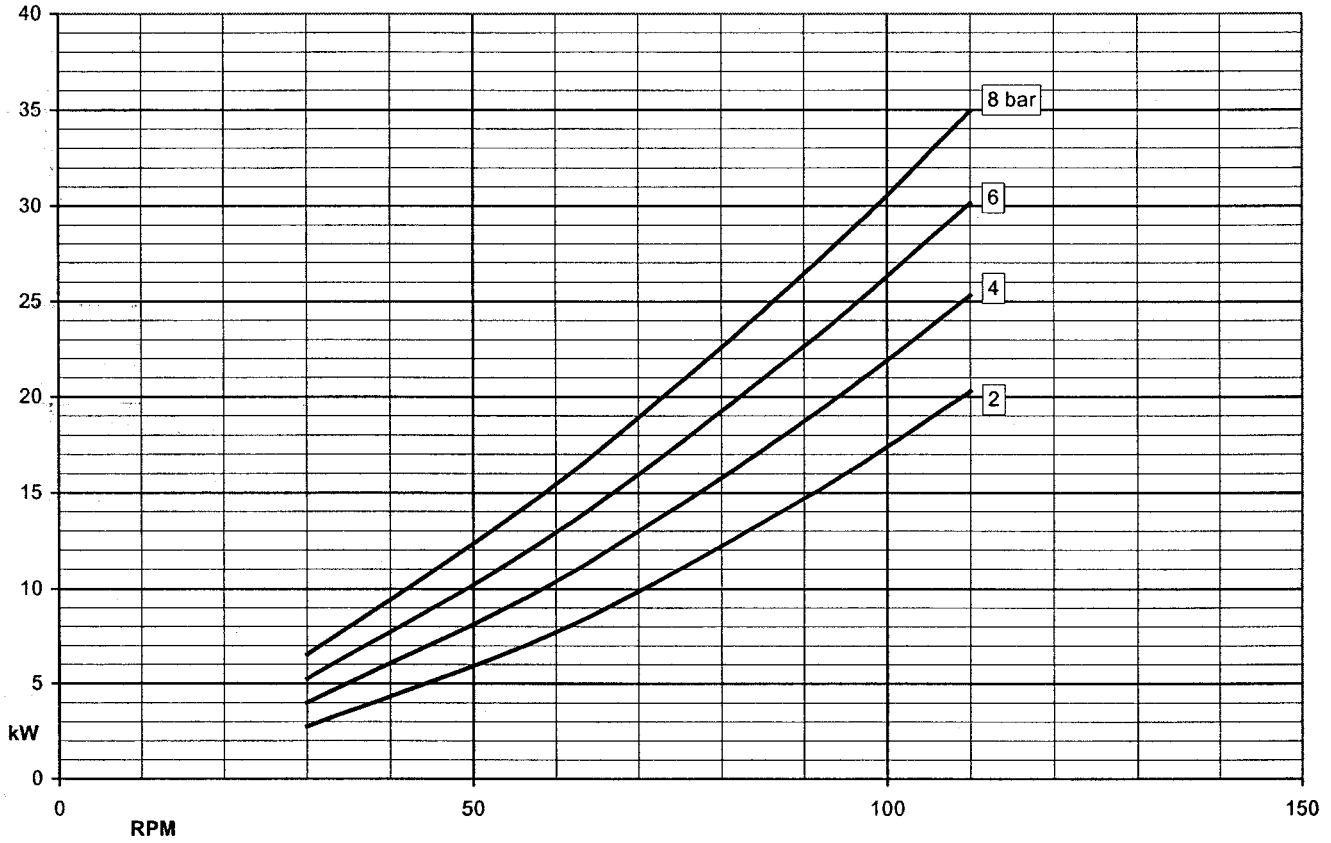

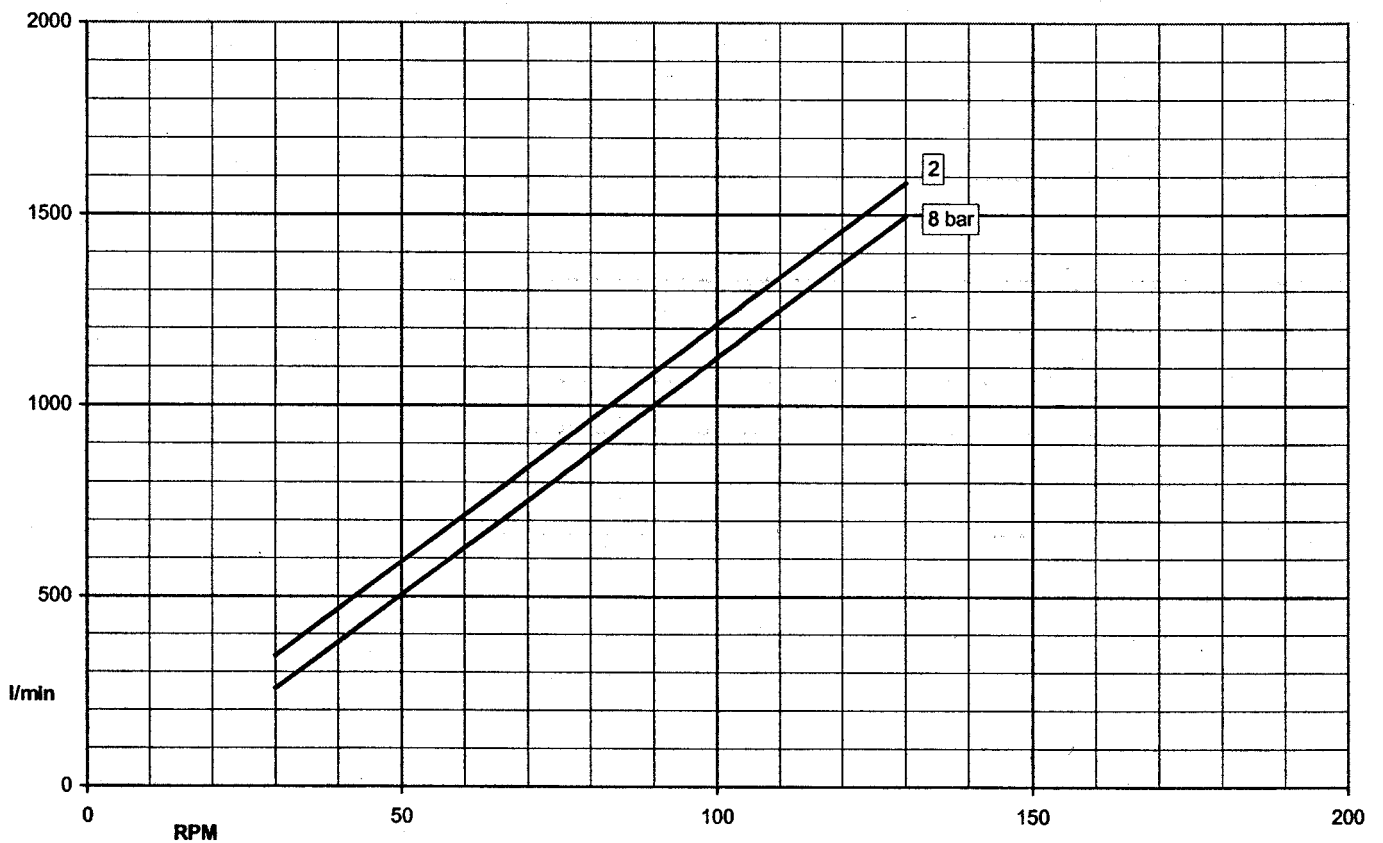
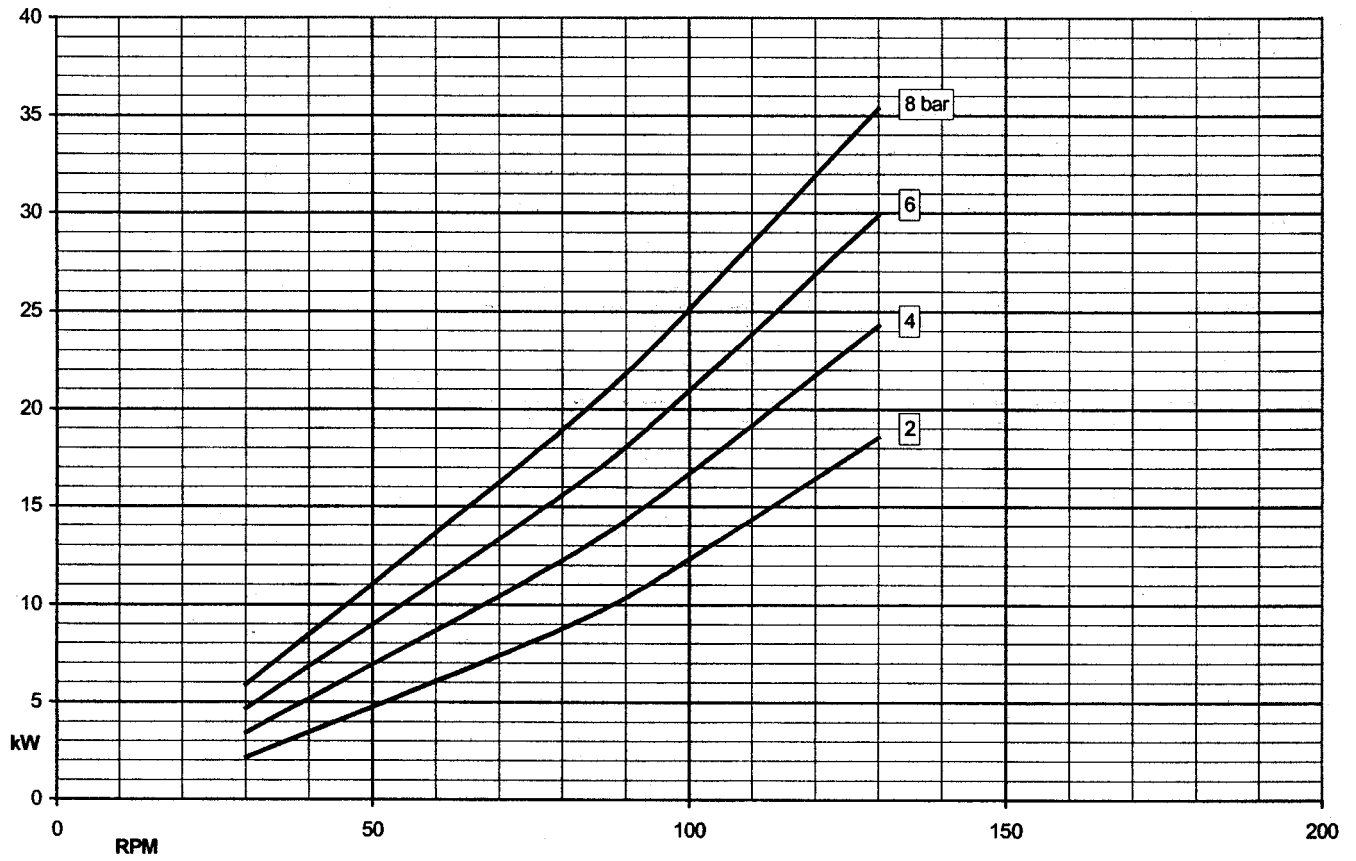

Viscosity: 20 mm²/s (cSt)

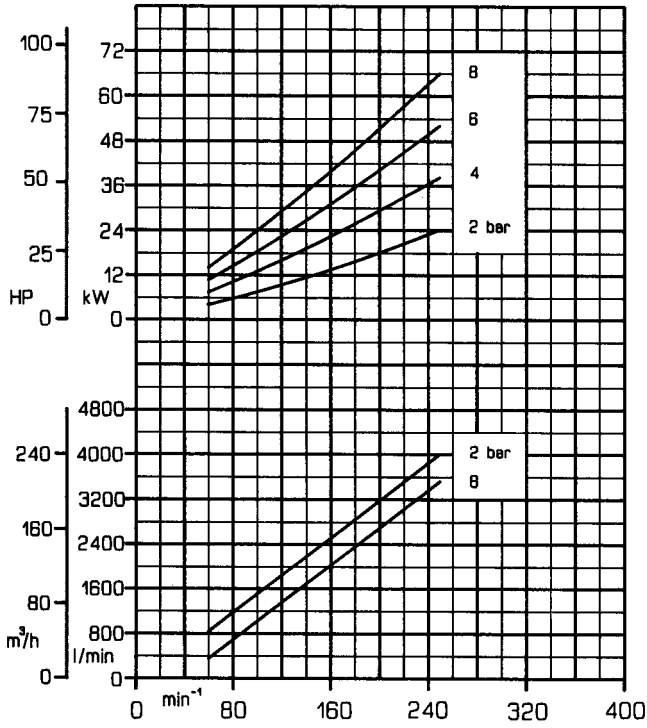

Viscosity: 60 mm²/s (cSt)

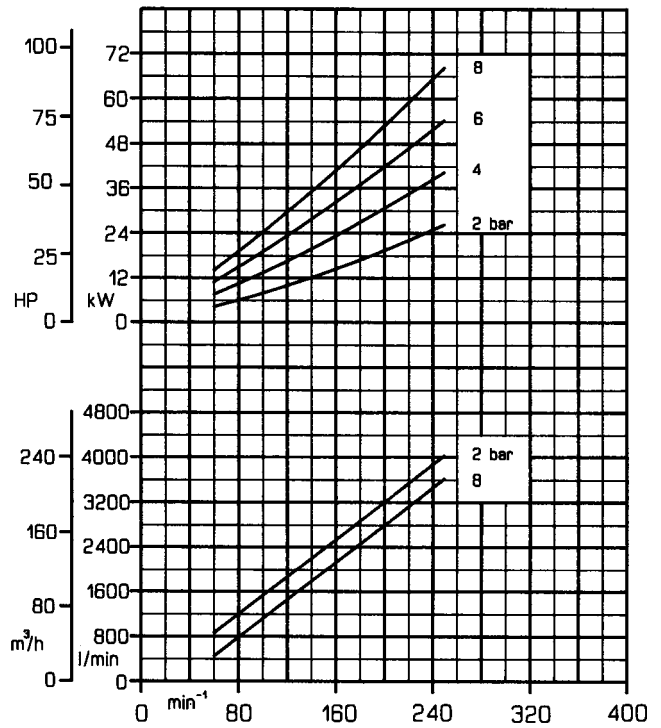

Viscosity: 200 mm²/s (cSt)

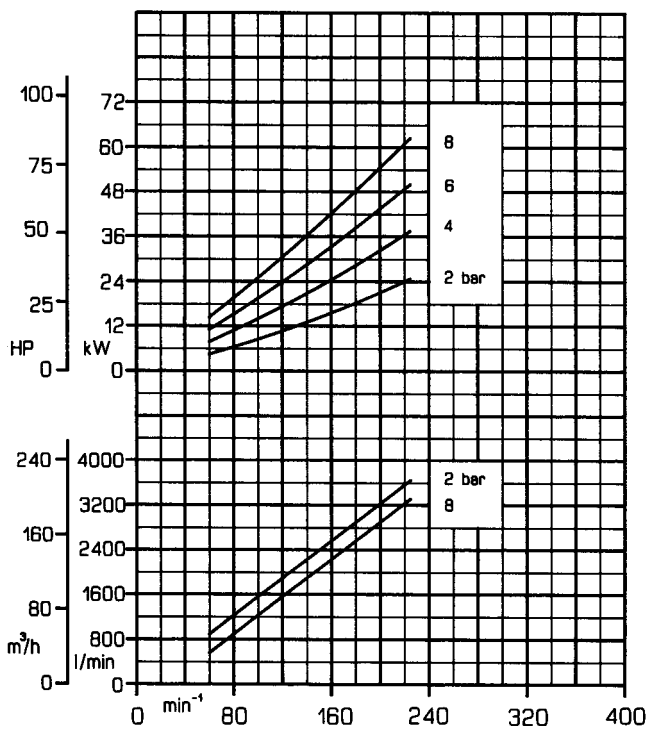

Viscosity: 600 mm²/s (cSt)

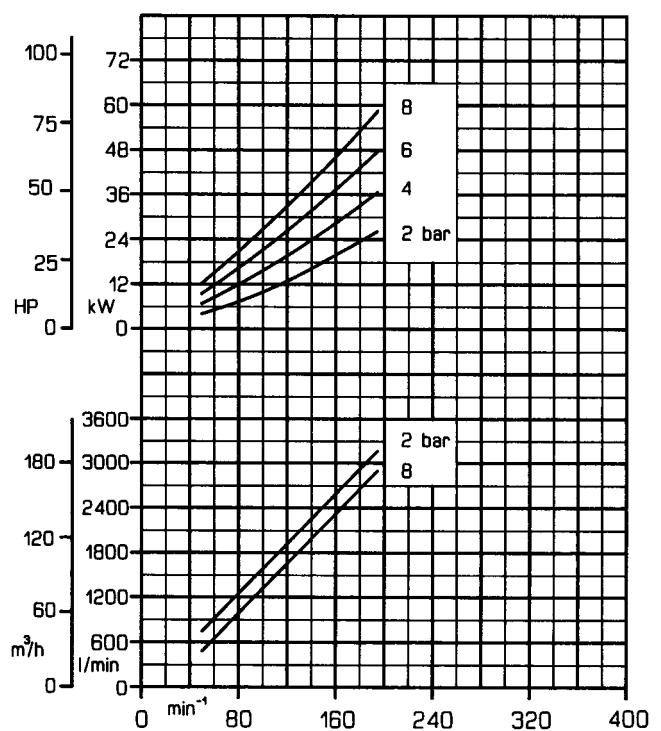

Viscosity: 2000 mm²/s (cSt)

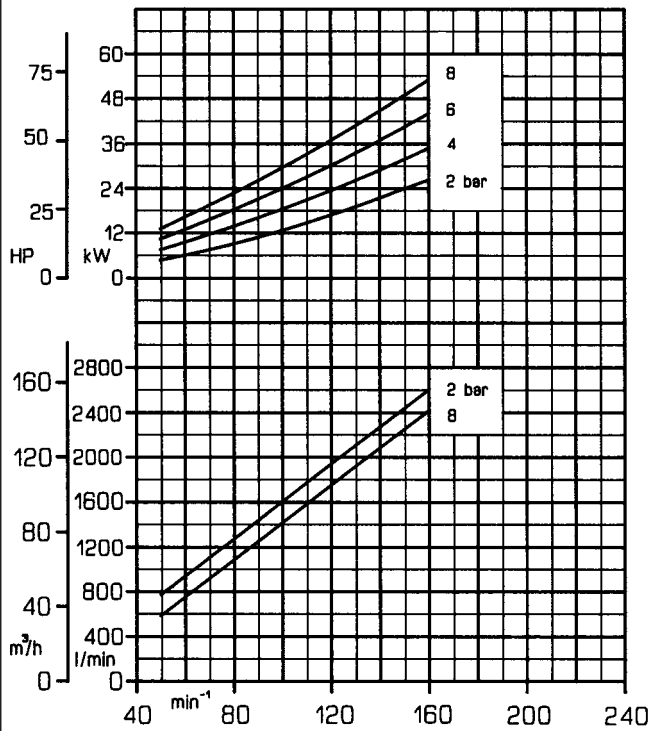

Viscosity: 6000 mm²/s (cSt)

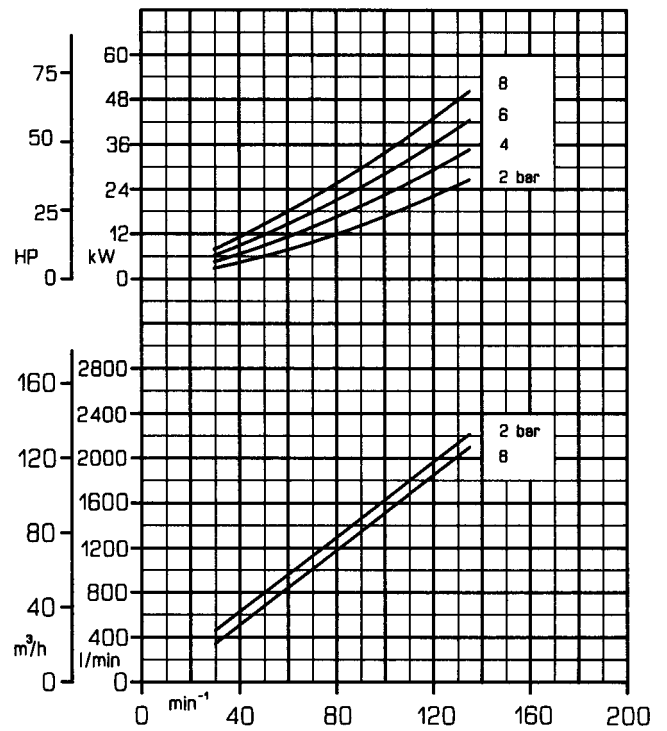

Viscosity: 20000 mm²/s (cSt)

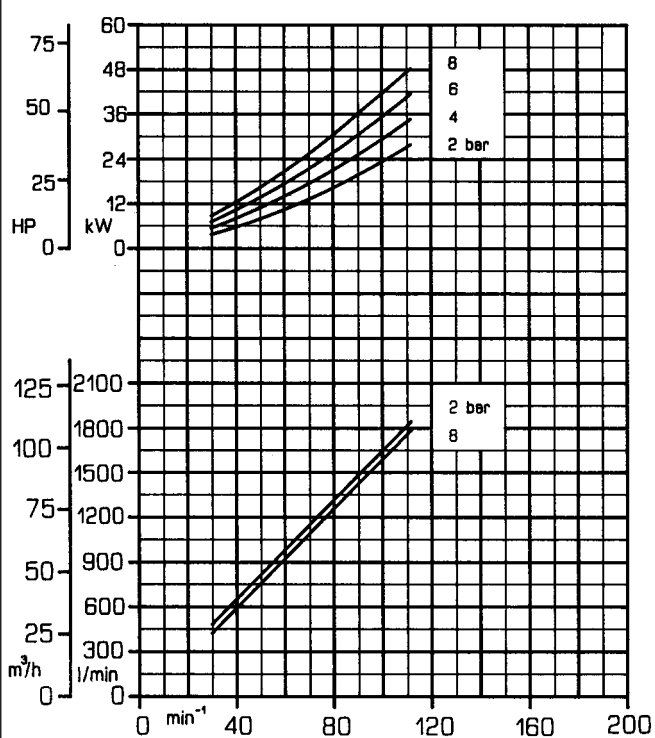

Viscosity: 60000 mm²/s (cSt)

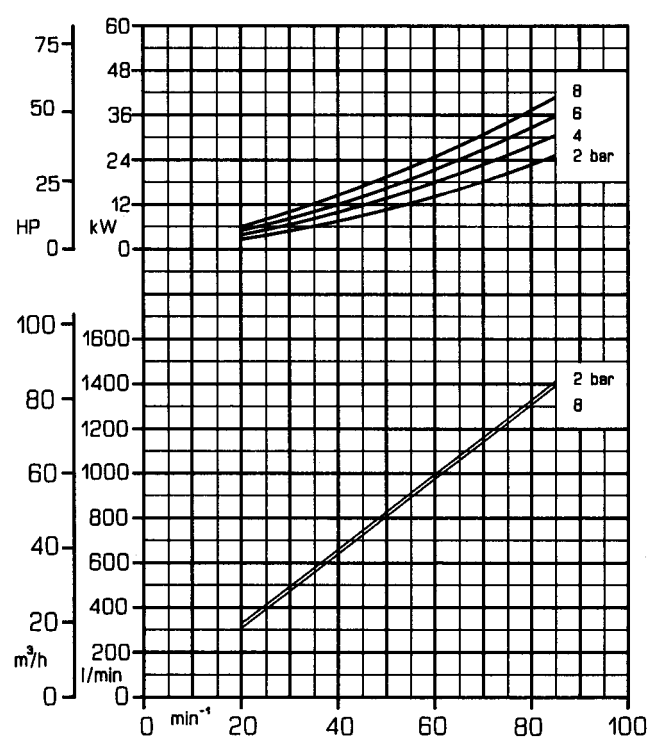

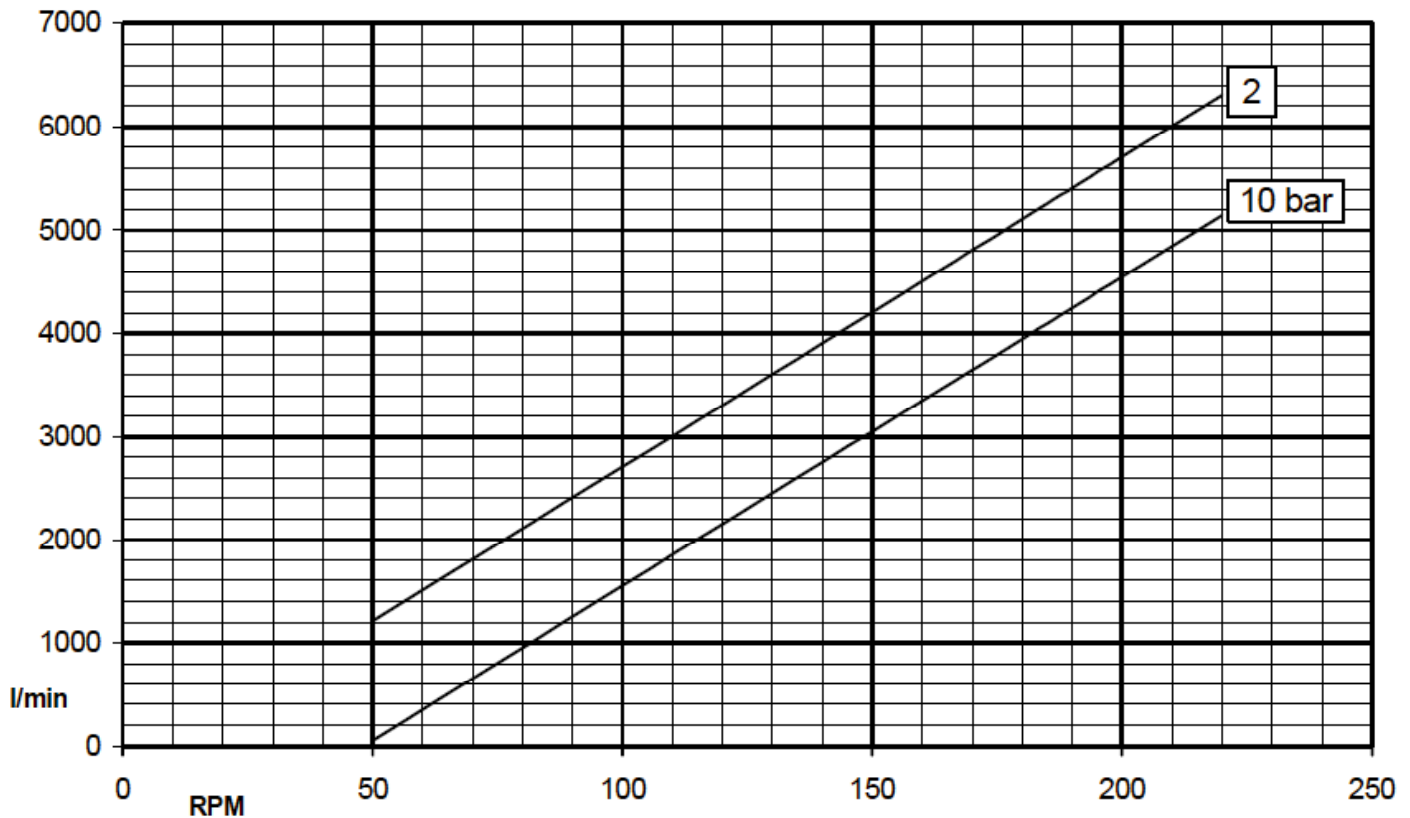
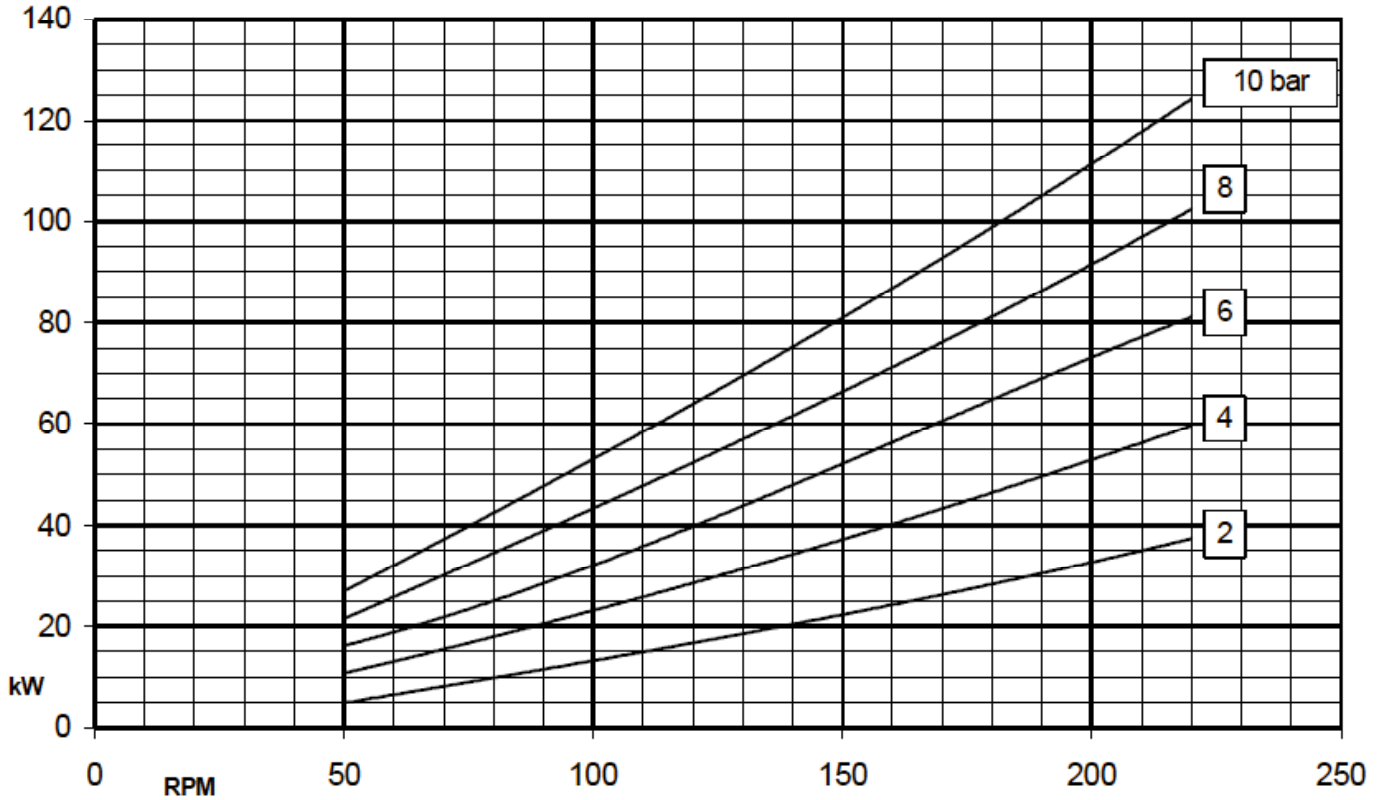

Viscosità / Viscosity : 60 cSt
Cilindrata / Displacement : 30 litri / litres

Rev.00

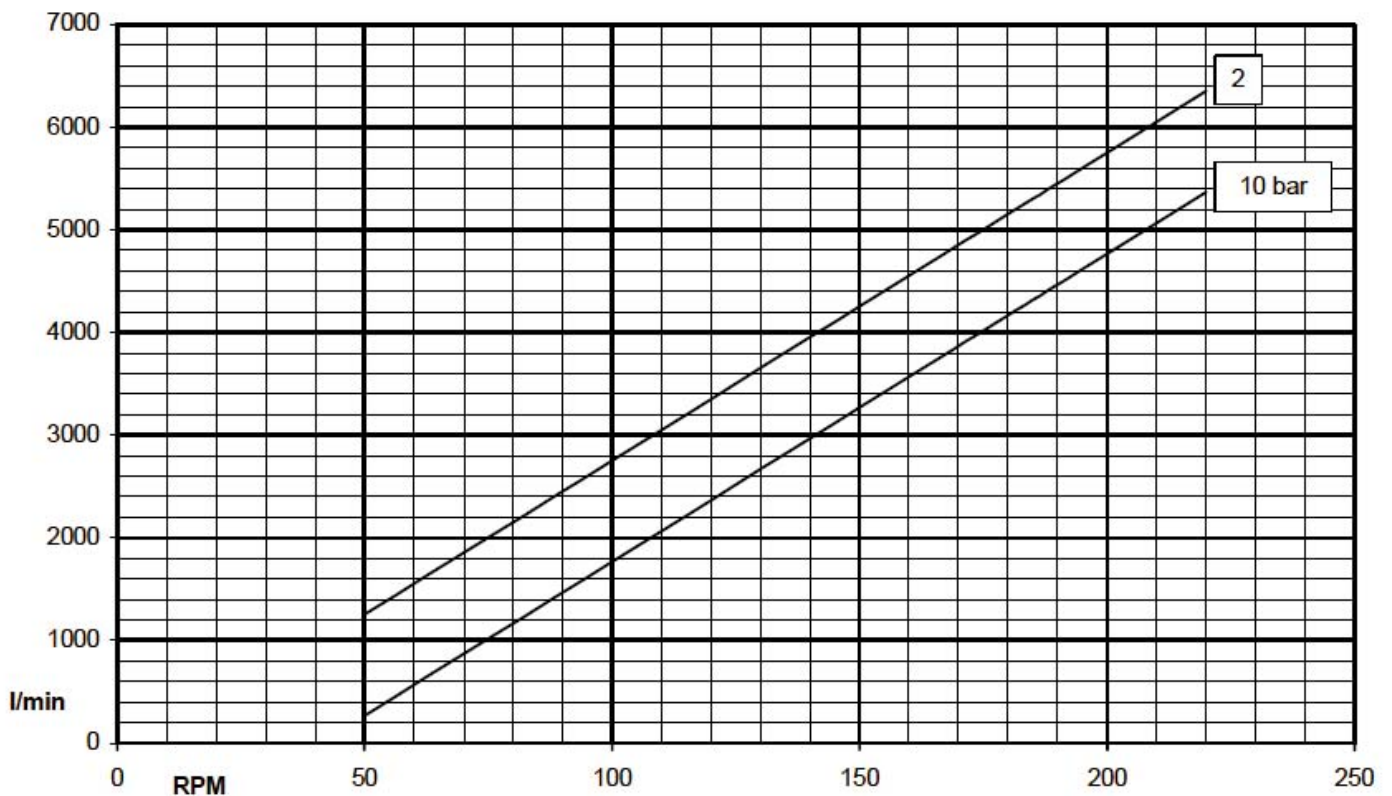
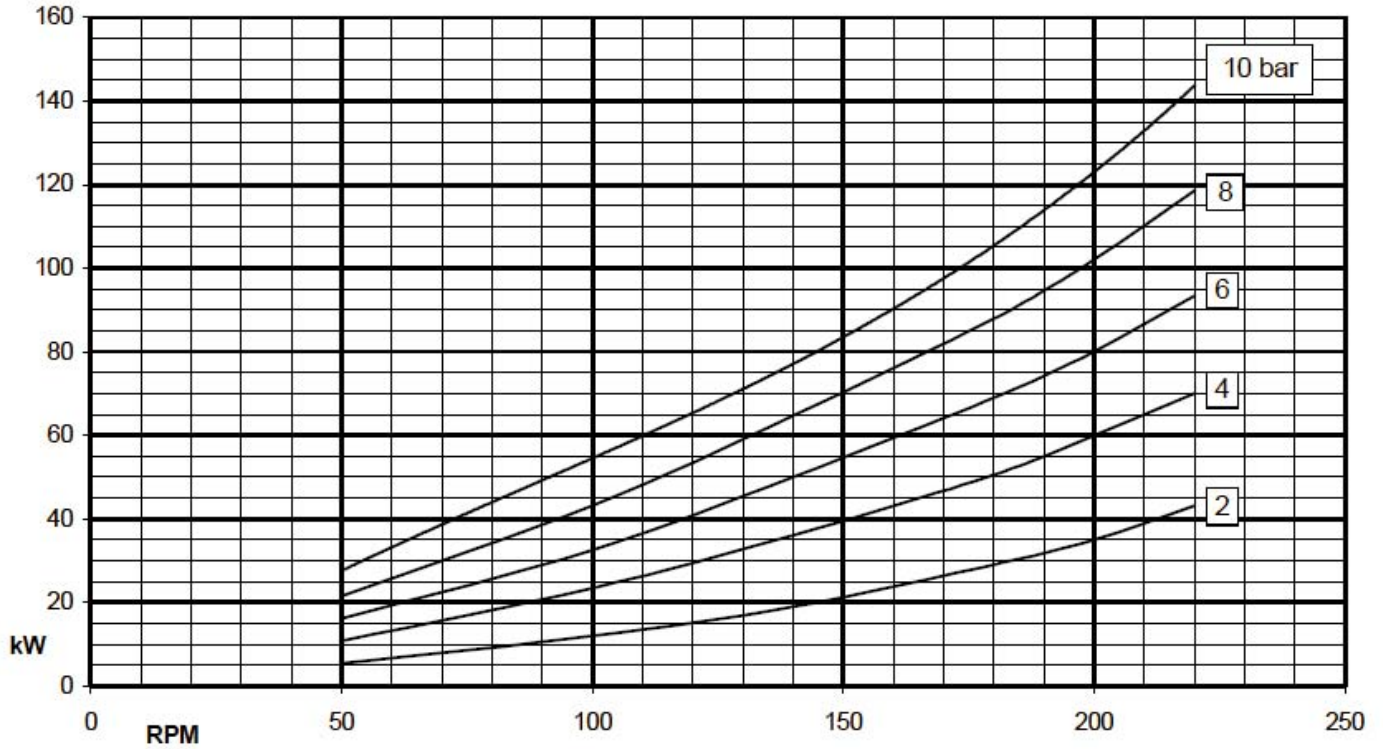

Viscosità / Viscosity : 200 cSt
Cilindrata / Displacement : 30 litri / litres

Rev.00

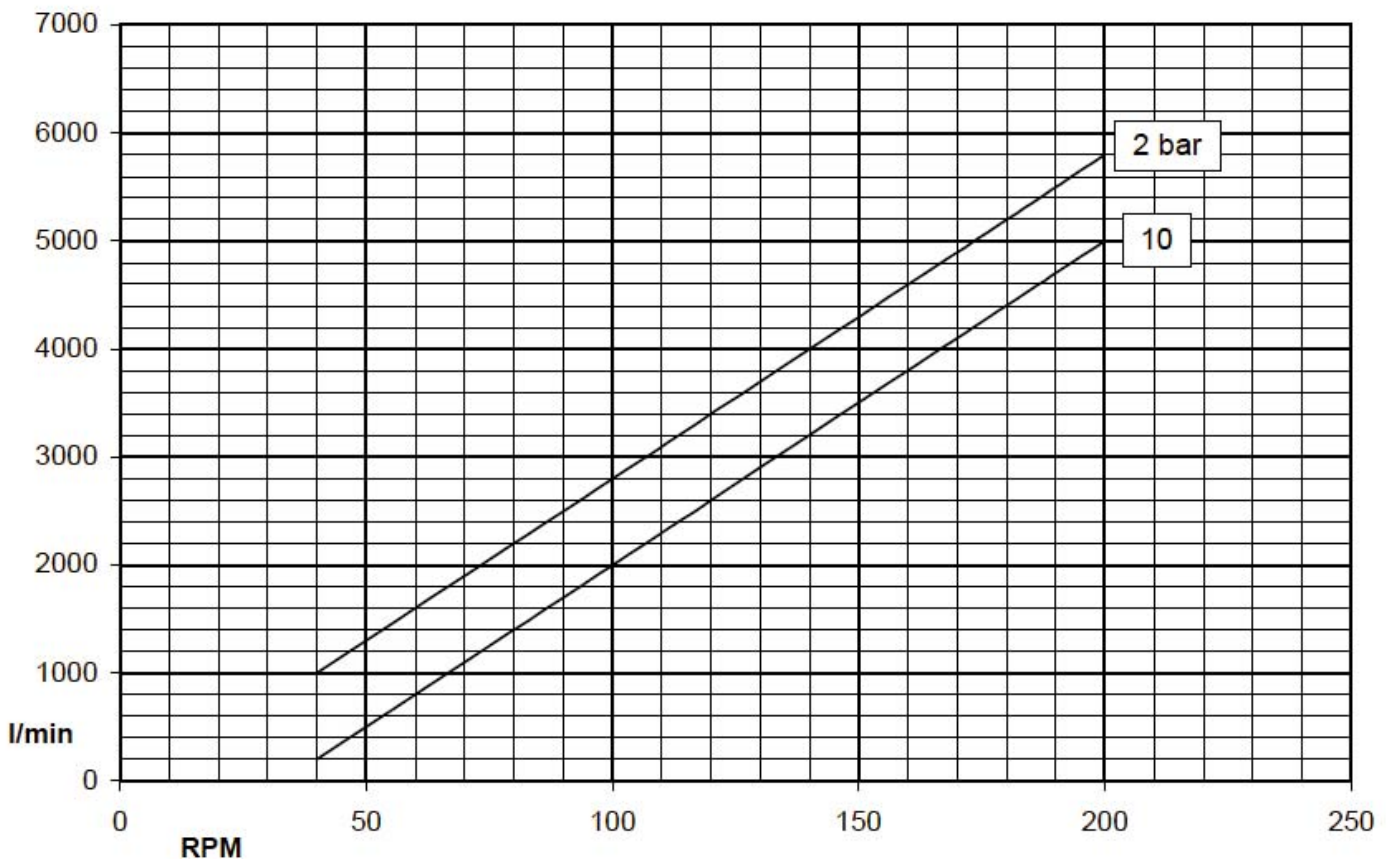
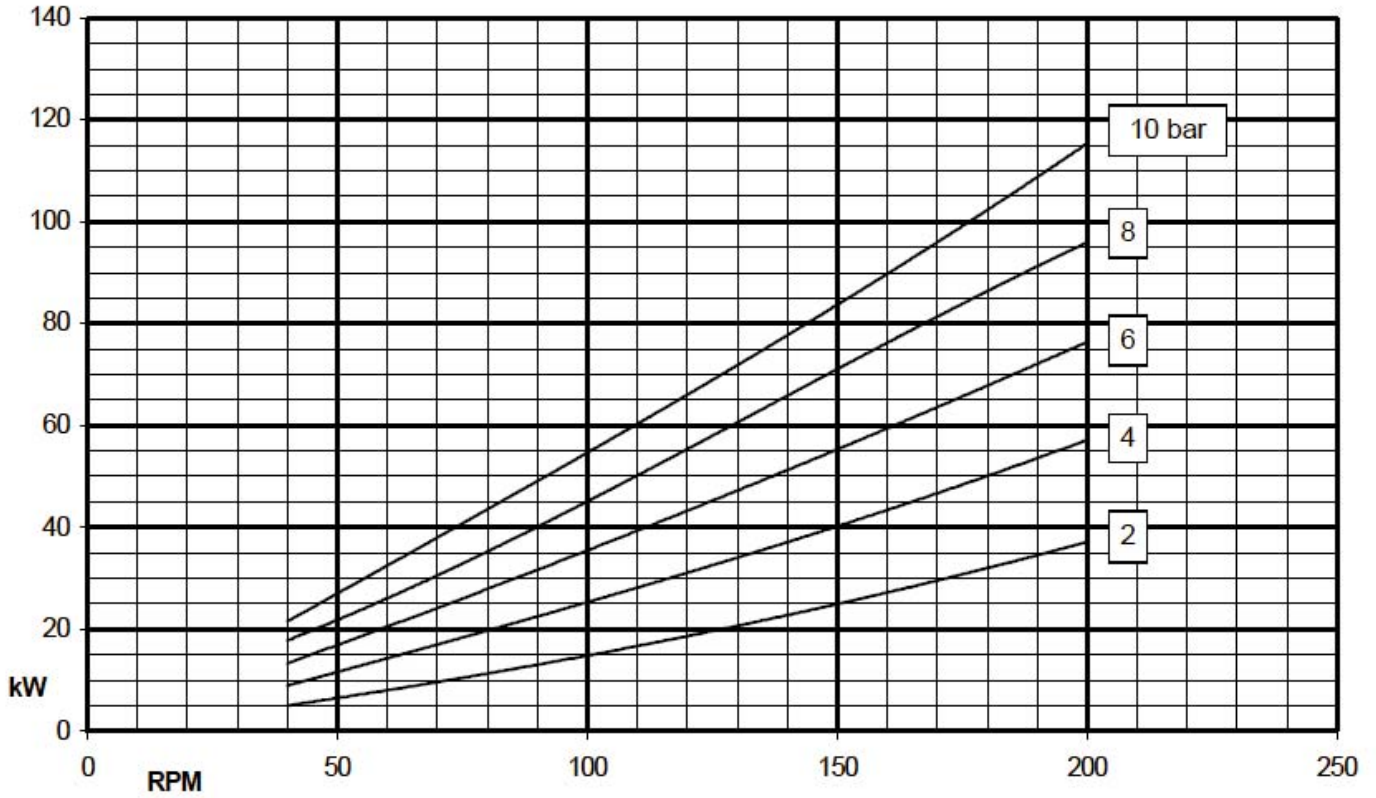

Viscosità / Viscosity : 600 cSt
Cilindrata / Displacement : 30 litri / litres

Rev.00

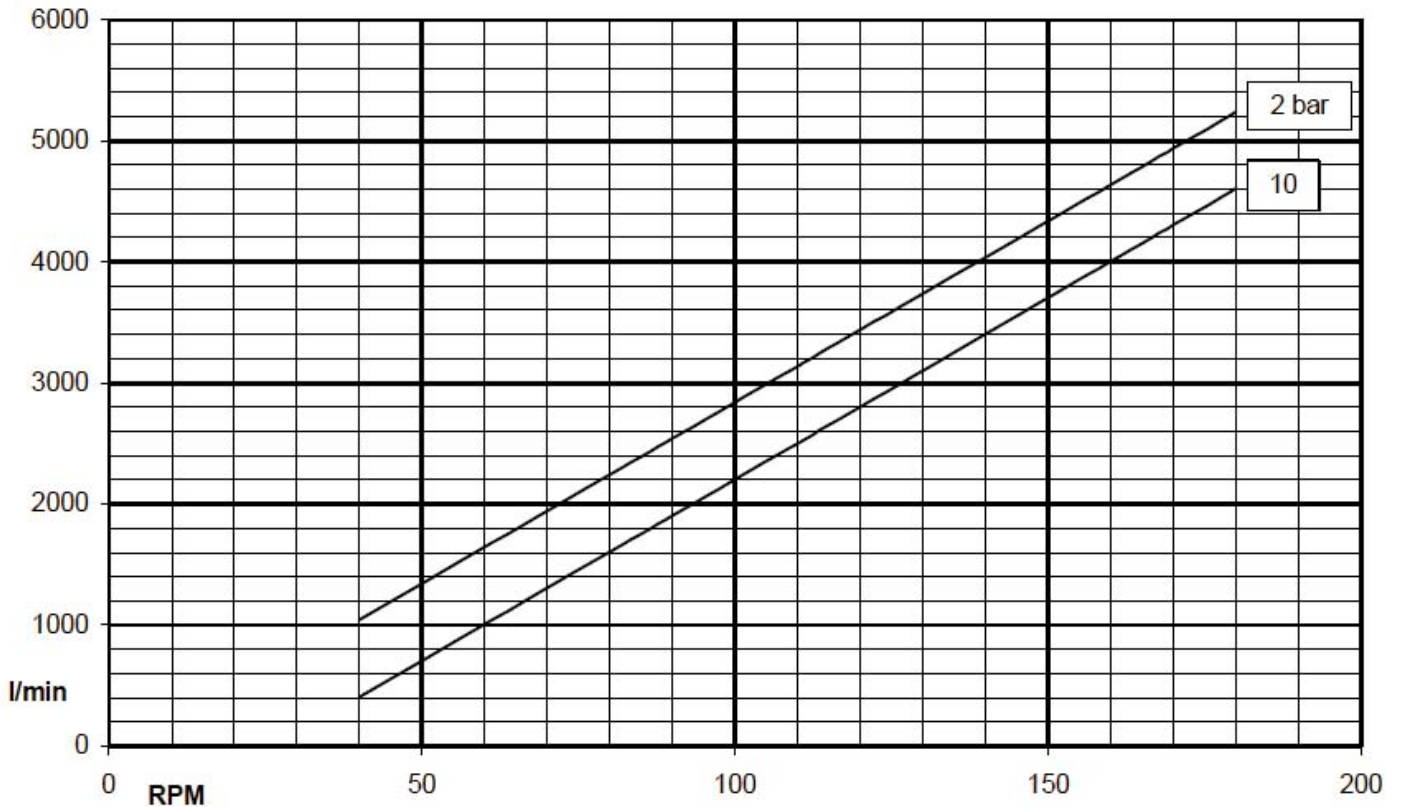
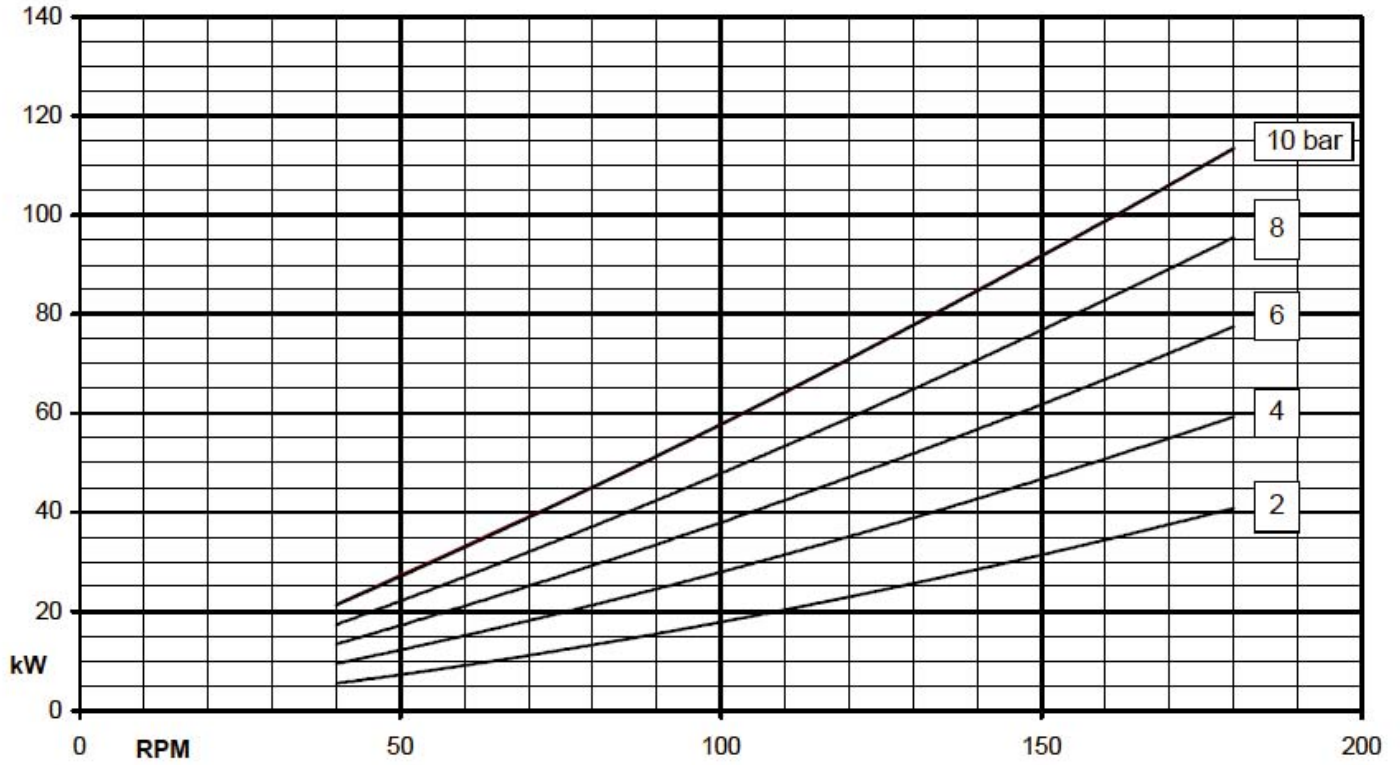

Viscosità / Viscosity : 2000 cSt
Cilindrata / Displacement : 30 litri / litres

Rev.00

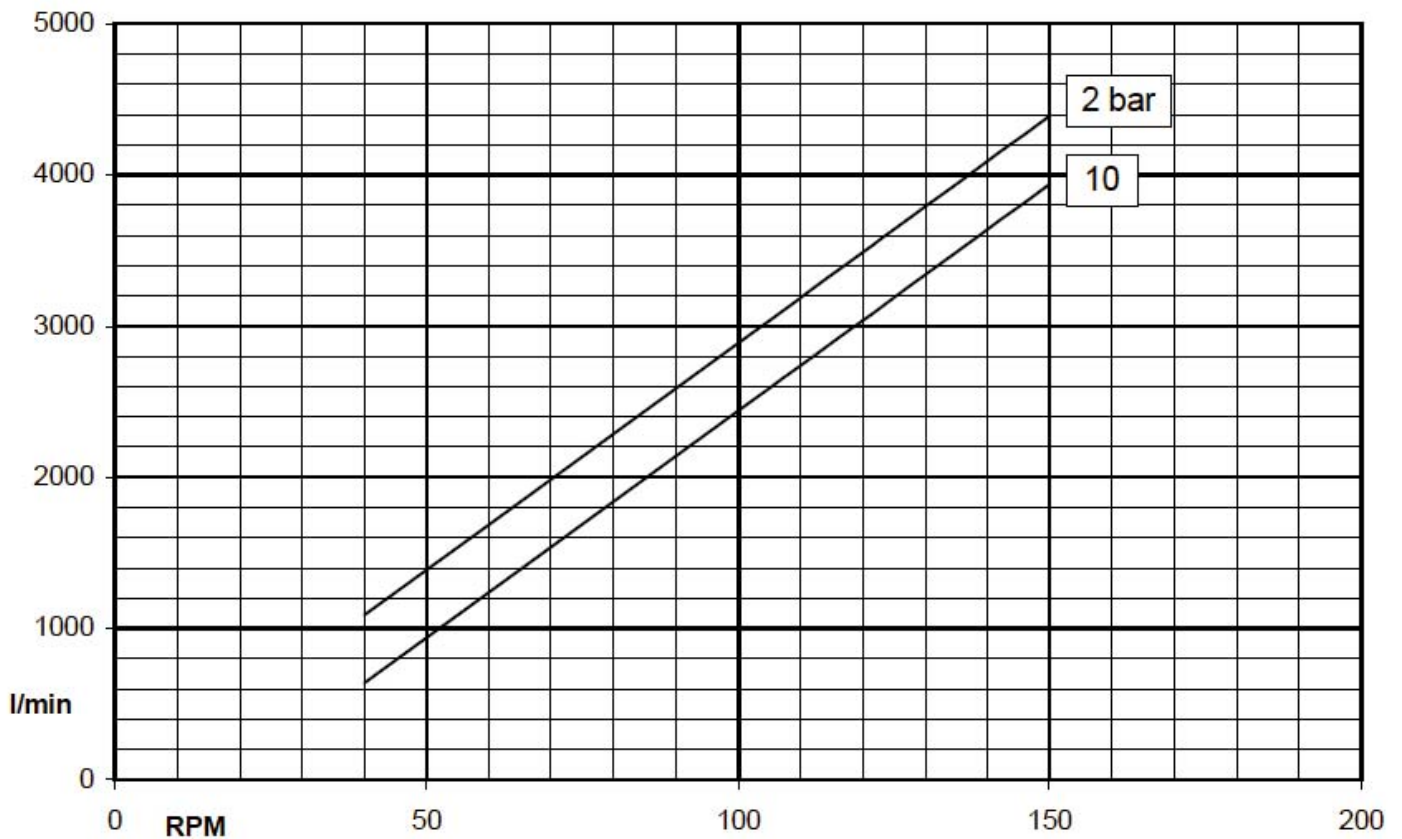
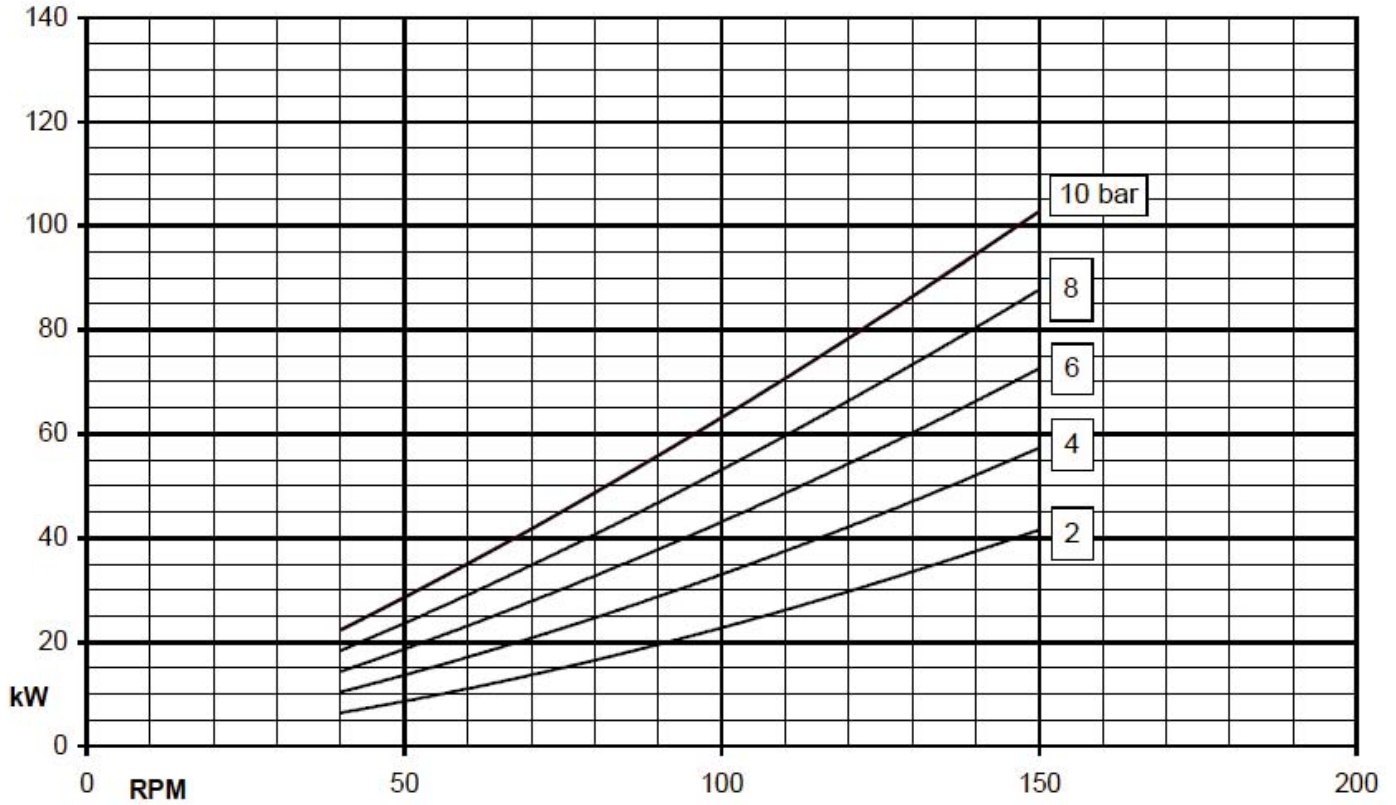

Viscosità / Viscosity : 6000 cSt
Cilindrata / Displacement : 30 litri / litres

Rev.00

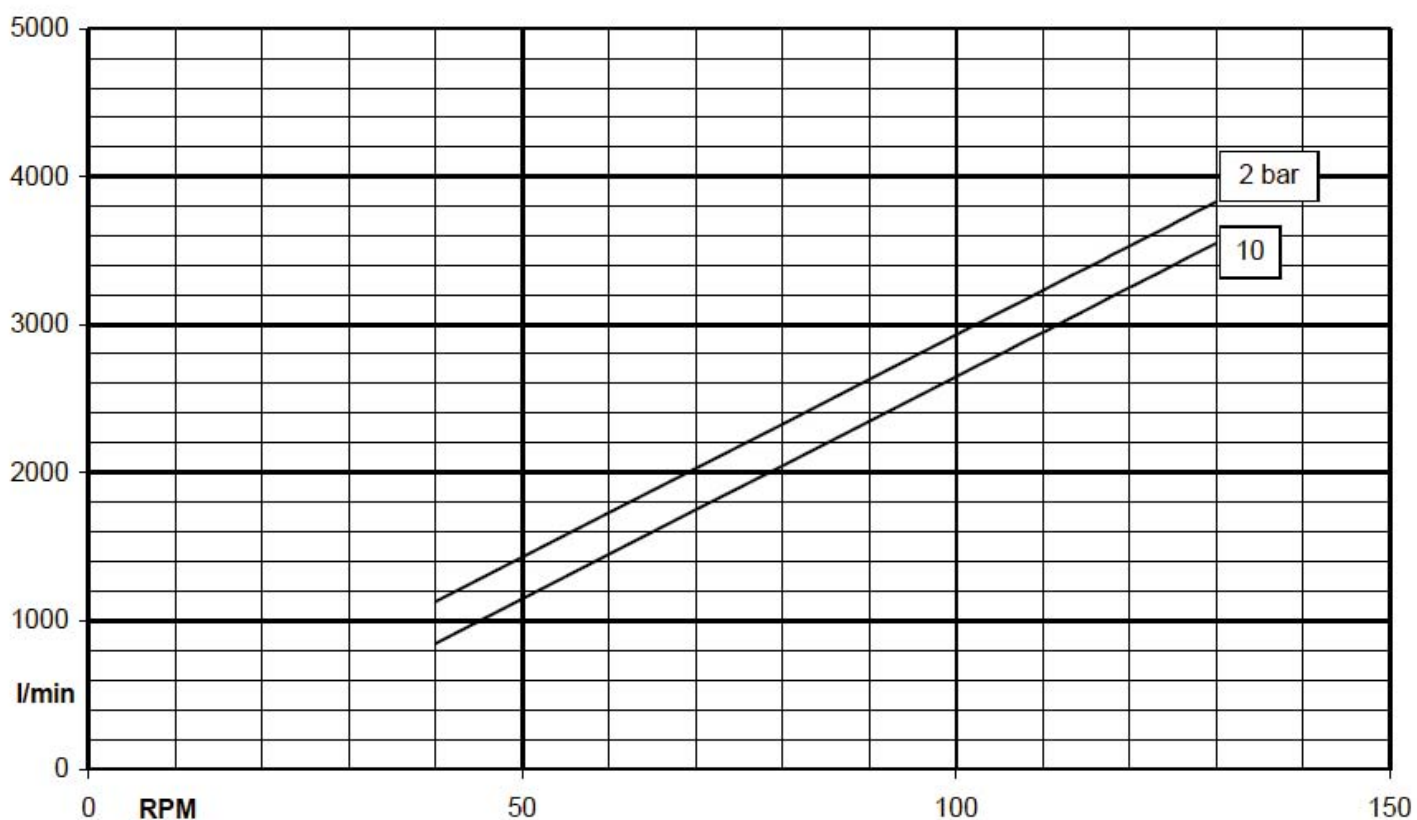
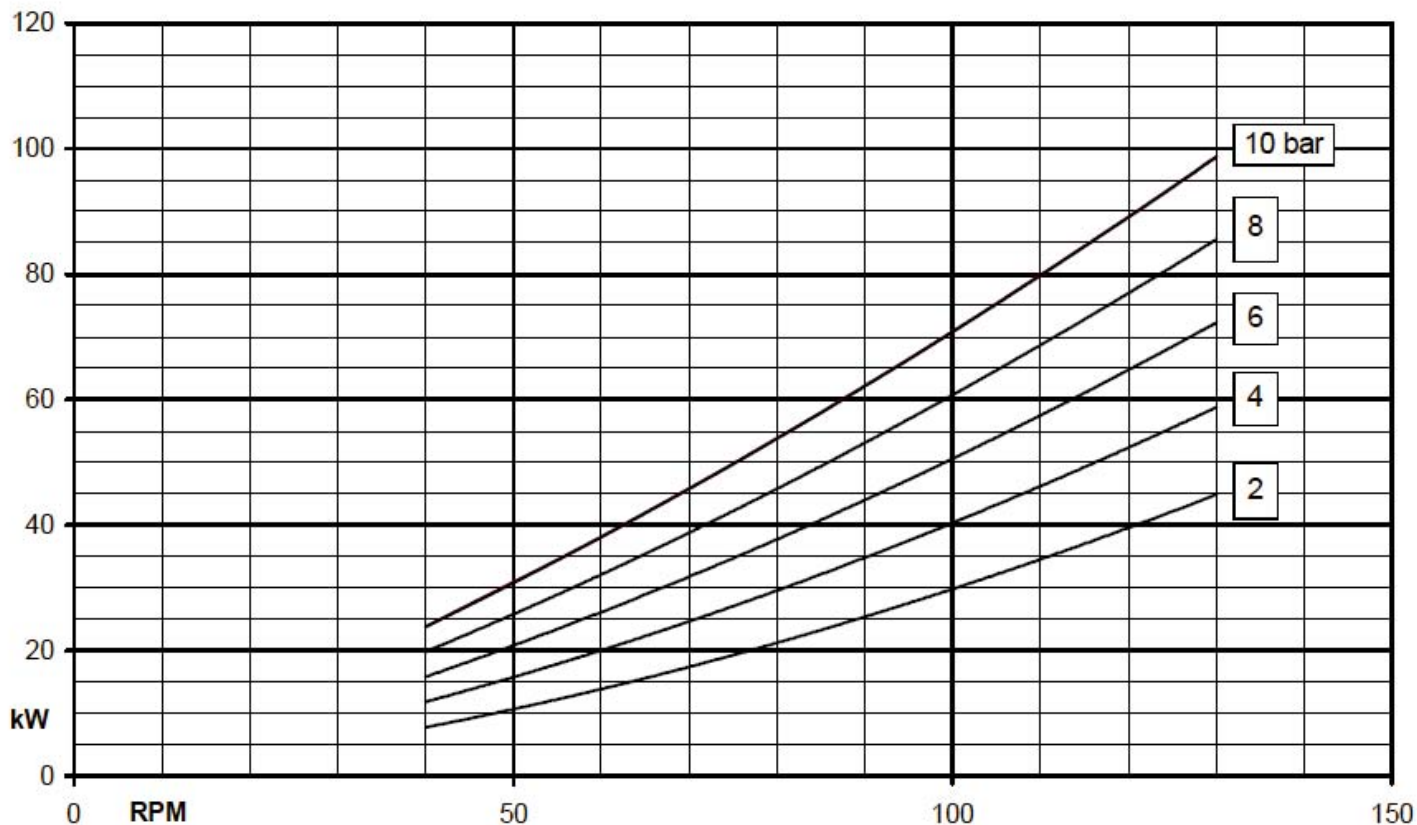

Viscosità / Viscosity : 20000 cSt
Cilindrata / Displacement : 30 litri / litres

Rev.00

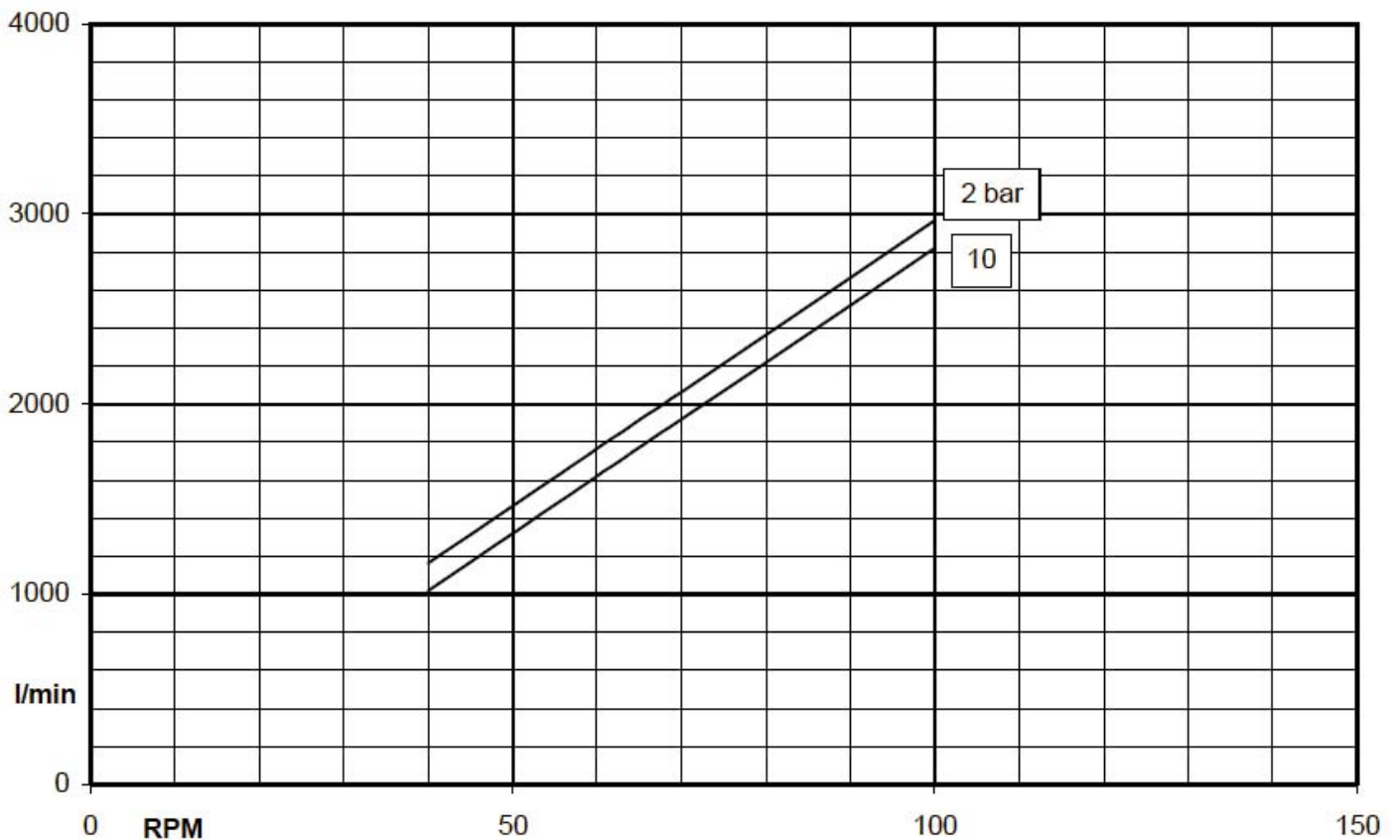
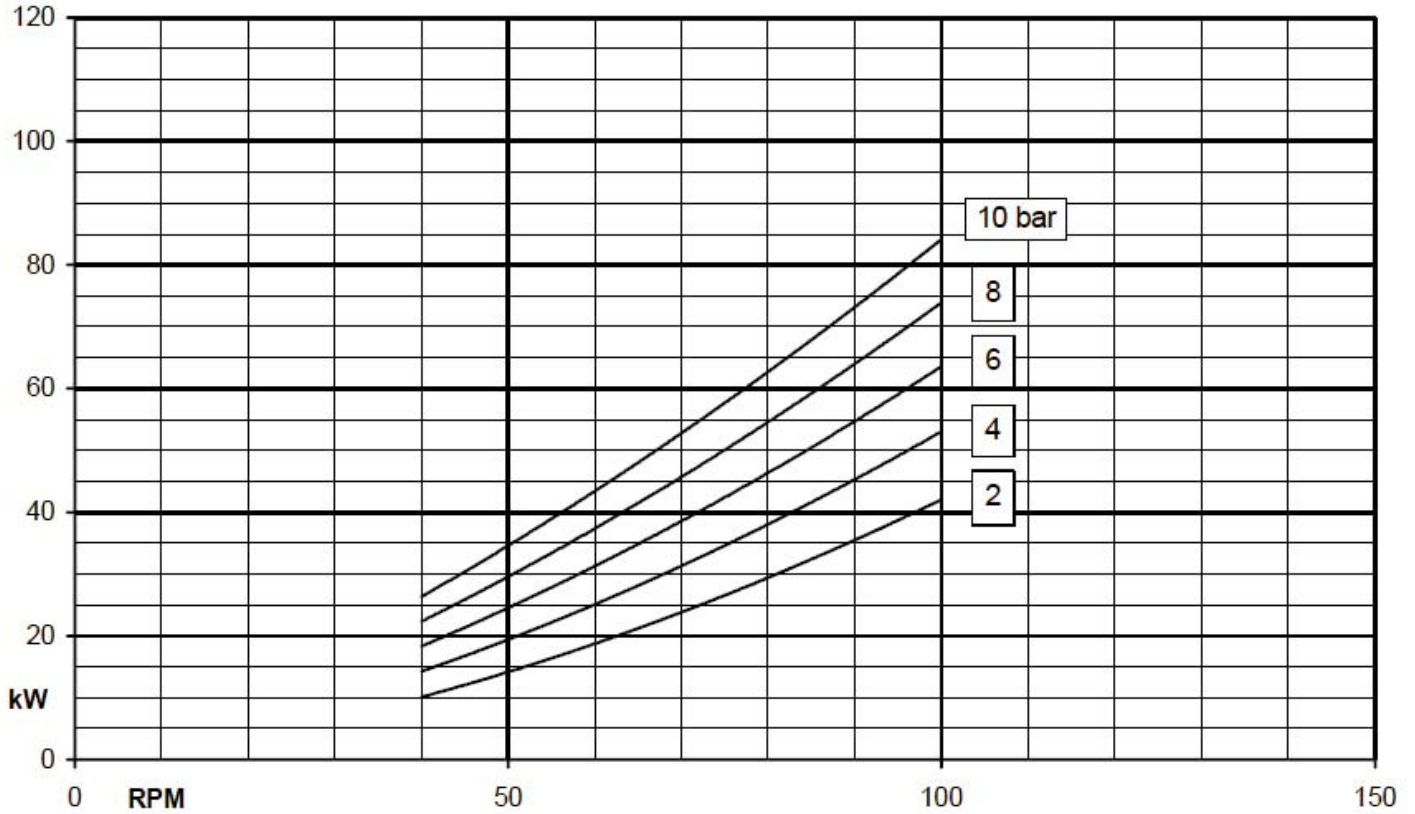

Viscosità / Viscosity : 60000 cSt
Cilindrata / Displacement : 30 litri / litres

Rev.00

